

Adversarial Search



Berlin Chen

Department of Computer Science & Information Engineering
National Taiwan Normal University



References:

1. S. Russell and P. Norvig. *Artificial Intelligence: A Modern Approach*. Chapter 6
2. N. J. Nilsson. *Artificial Intelligence: A New Synthesis*. Chapter 12
3. S. Russell's teaching materials

Introduction

- Game theory
 - First developed by von Neumann and Morgensten
 - Widely studied by economists, mathematicians, financiers, etc.
 - The action of one player (agent) can significantly affect the utilities of the others
 - Cooperative or competitive
 - Deal with the environments with multiple agents

- Most games studied in AI are

- Deterministic (**but strategic**) (state, action(state)) → next state
- Turn-taking
- Two-player
- Zero-sum
- Perfect information



This means deterministic, fully observable environments in which there are two agents whose actions must **alternate** and in which the utility values at the end of game are always equal or opposite

But not physical games

Types of Games

	Deterministic	chance
Perfect information	Chess, Checkers, Go, Othello	Backgammon
Imperfect information		Bridge, Poker

- Games are one of the first tasks undertaken in AI
 - The abstract nature of (nonphysical) games makes them an appealing subject in AI
- Computers have surpassed humans in *checkers* and *Othello*, and have defeated human champions in *chess* and *backgammon*
- However, in *Go*, computers still perform at the amateur level

Games as Search Problems

- Games are usually too hard to solve
 - E.g., a chess game
 - Average branching factor: 35
 - Average moves by each player: 50
 - Total number of nodes in the search tree: 35^{100} or 10^{154}
 - Total number of distinct states: 10^{40}
- The solution is a **strategy** that specifies a move for every possible opponent reply
 - **Time limit**: how to make the best possible use of time?
 - Calculate the optimal decision may be infeasible
 - Pruning is needed
 - **Uncertainty**: due to the opponent's actions and game complexity
 - Imperfect information
 - Chance

Scenario

- Games with two players
 - MAX, moves first
 - MIN, moves second

} Then, taking turns

- At the end of the game
 - Winner awarded and loser penalized
 - Or, draw
- Can be formally defined as a kind of search problem

Sense → Plan → Act

Games as Search Problems

- Main components should be specified

- **Initial State**

- Board position, which player to move

- **Successor Function**

- A list of legal (*move*, *state*) pairs for each state indicating a legal move and the resulting state

- **Terminal Test**

- Determine when the game is over
- Terminal states: states where the game has ended

- **Utility Function** (objective/payoff function)

- Give numeric values for all terminal states, e.g.:
 - Win, loss or draw : +1, -1, 0
 - Or values with a wider variety

Define the
game tree

From the viewpoint
of MAX

Example Game Tree for Tic-Tac-Toe

- Tic-Tac-Toe also called Noughts and Crosses
 - 2-player, deterministic, alternating

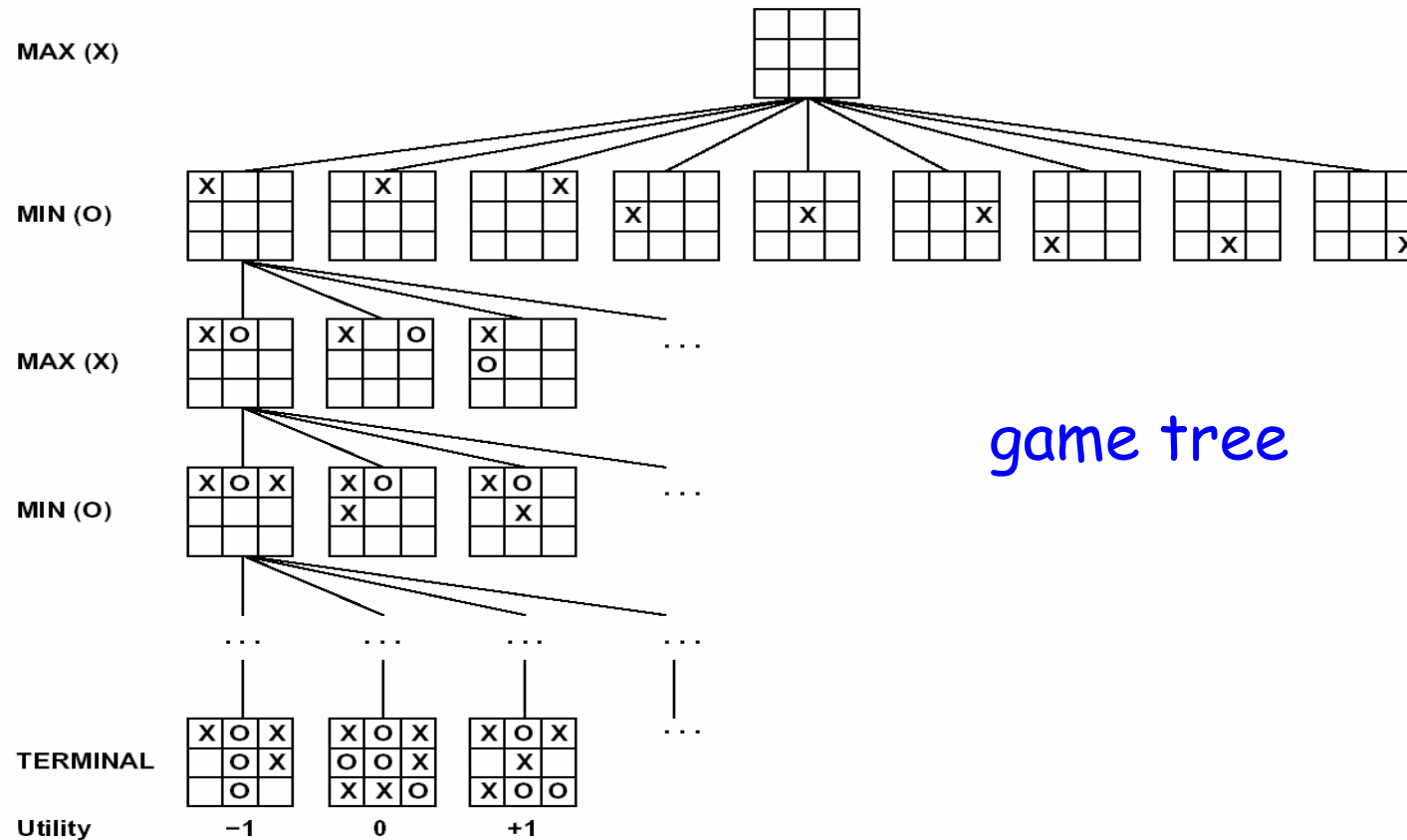

- The numbers on leaves indicate the utility values of terminal states from the point of view of the **MAX**

Minimax Search

- A strategy/solution for **optimal** decisions
- Examine the minimax value of each node in the game tree

Minmax-Value(n) =

$$\begin{cases} \text{Utility}(n) & \text{if } n \text{ is a terminal state} \\ \max_{s \in \text{Successor}(n)} \text{Minmax-Value}(s) & \text{if } n \text{ is a MAX node} \\ \min_{s \in \text{Successor}(n)} \text{Minmax-Value}(s) & \text{if } n \text{ is a MIN node} \end{cases}$$

- Minmax value of a terminal state is just the utility from the point of view of MAX
- Assume two players (MAX and MIN) play optimally (infallibly) from the current node to the end of the game

Minimax Search (cont.)

- Example: a trivial 2-ply (one-move-deep) game
 - Perfect play for the deterministic, perfect-information game
 - MAX and MIN play optimally
 - Idea: Choose the move to a position with highest minimax value = best achievable payoff against best play

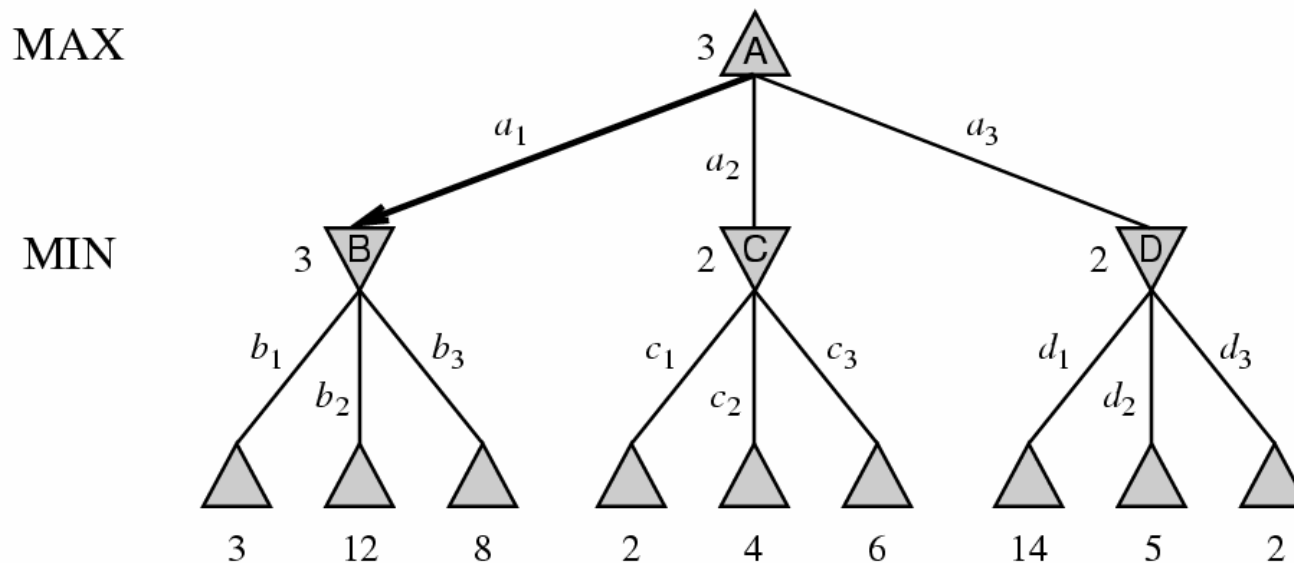

Tree for Tic-Tac-Toe

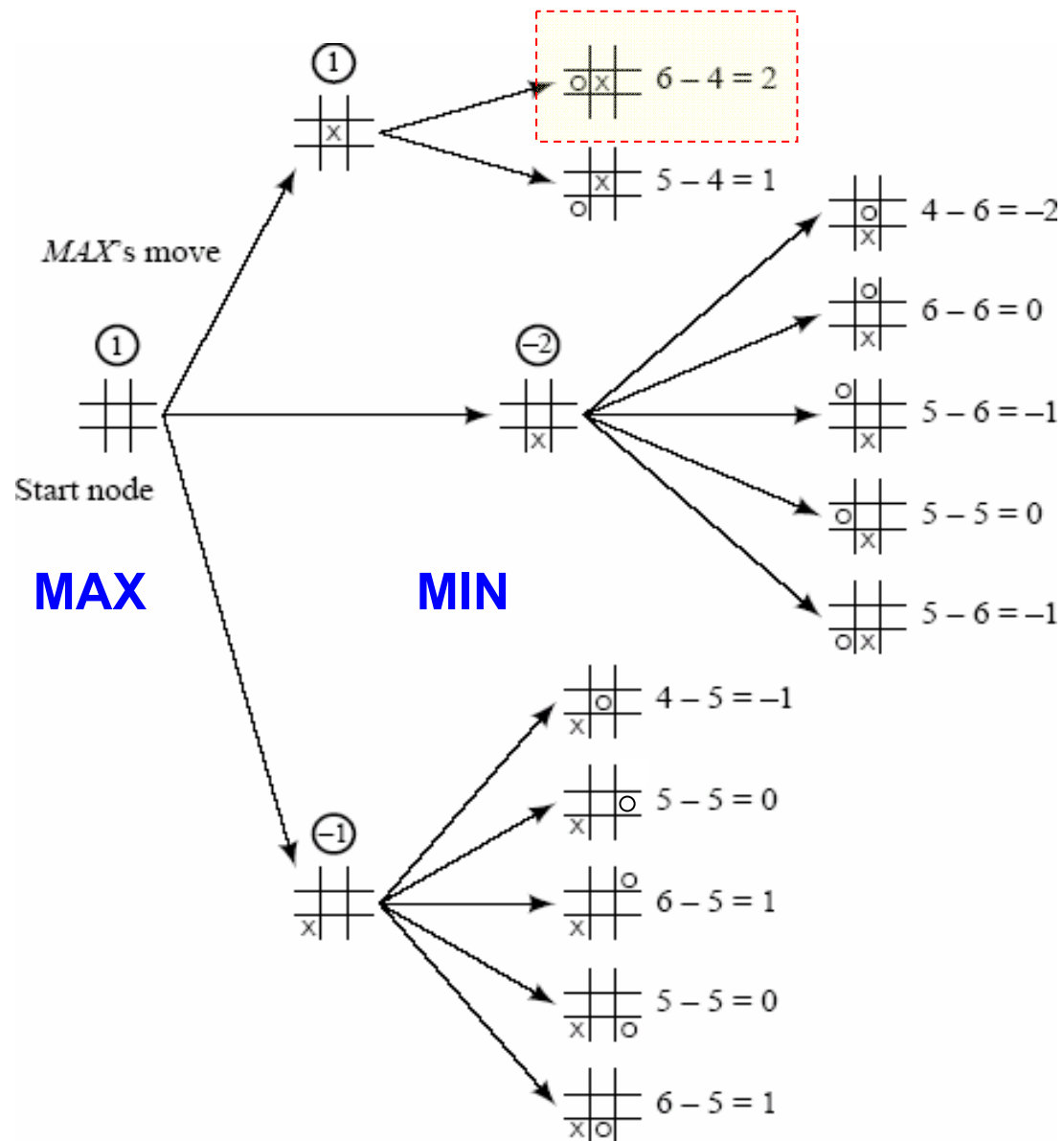

Tree for Tic-Tac-Toe (cont.)

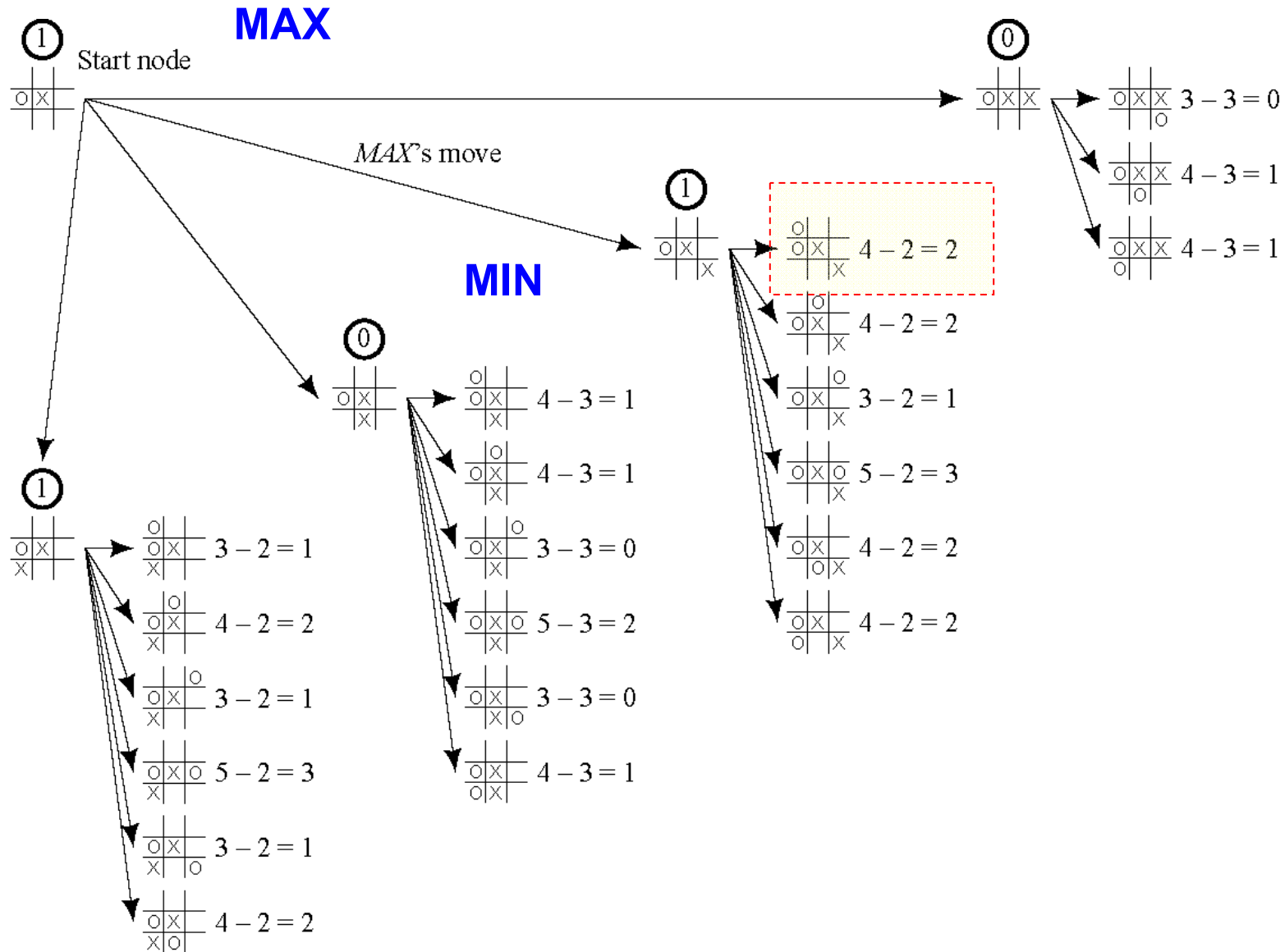

Tree for Tic-Tac-Toe (cont.)

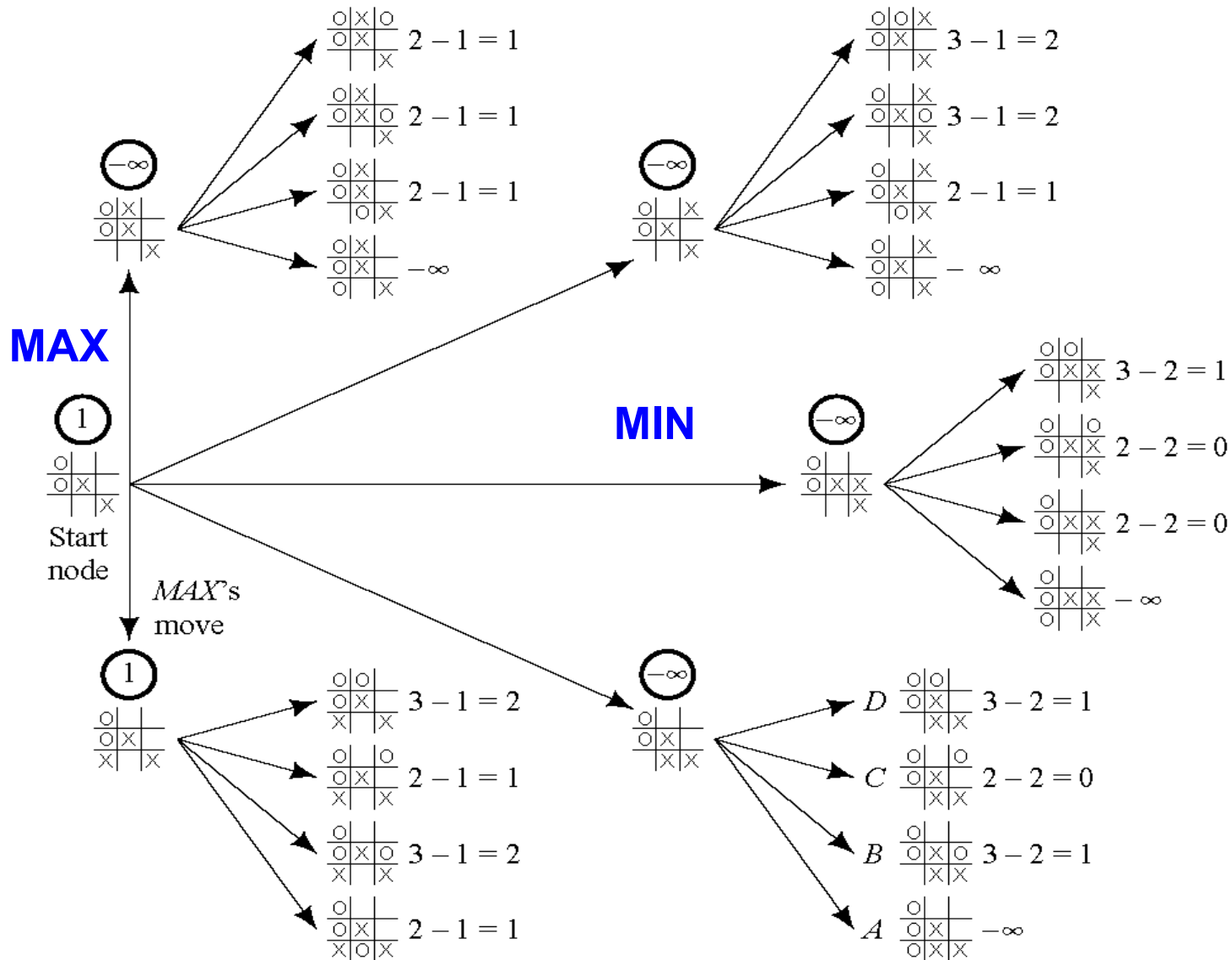

Minimax Search: Algorithm

function MINIMAX-DECISION(*state*) *returns an action*
inputs: *state*, current state in game

 $v \leftarrow \text{MAX-VALUE}(\textit{state})$
return the *action* in SUCCESSORS(*state*) with value v

function MAX-VALUE(*state*) *returns a utility value*
if TERMINAL-TEST(*state*) **then return** UTILITY(*state*)
 $v \leftarrow -\infty$
for a, s in SUCCESSORS(*state*) **do**
 $v \leftarrow \text{MAX}(v, \text{MIN-VALUE}(s))$
return v

For MAX Node

function MIN-VALUE(*state*) *returns a utility value*
if TERMINAL-TEST(*state*) **then return** UTILITY(*state*)
 $v \leftarrow \infty$
for a, s in SUCCESSORS(*state*) **do**
 $v \leftarrow \text{MIN}(v, \text{MAX-VALUE}(s))$
return v

For MIN Node

Minimax Search: Example

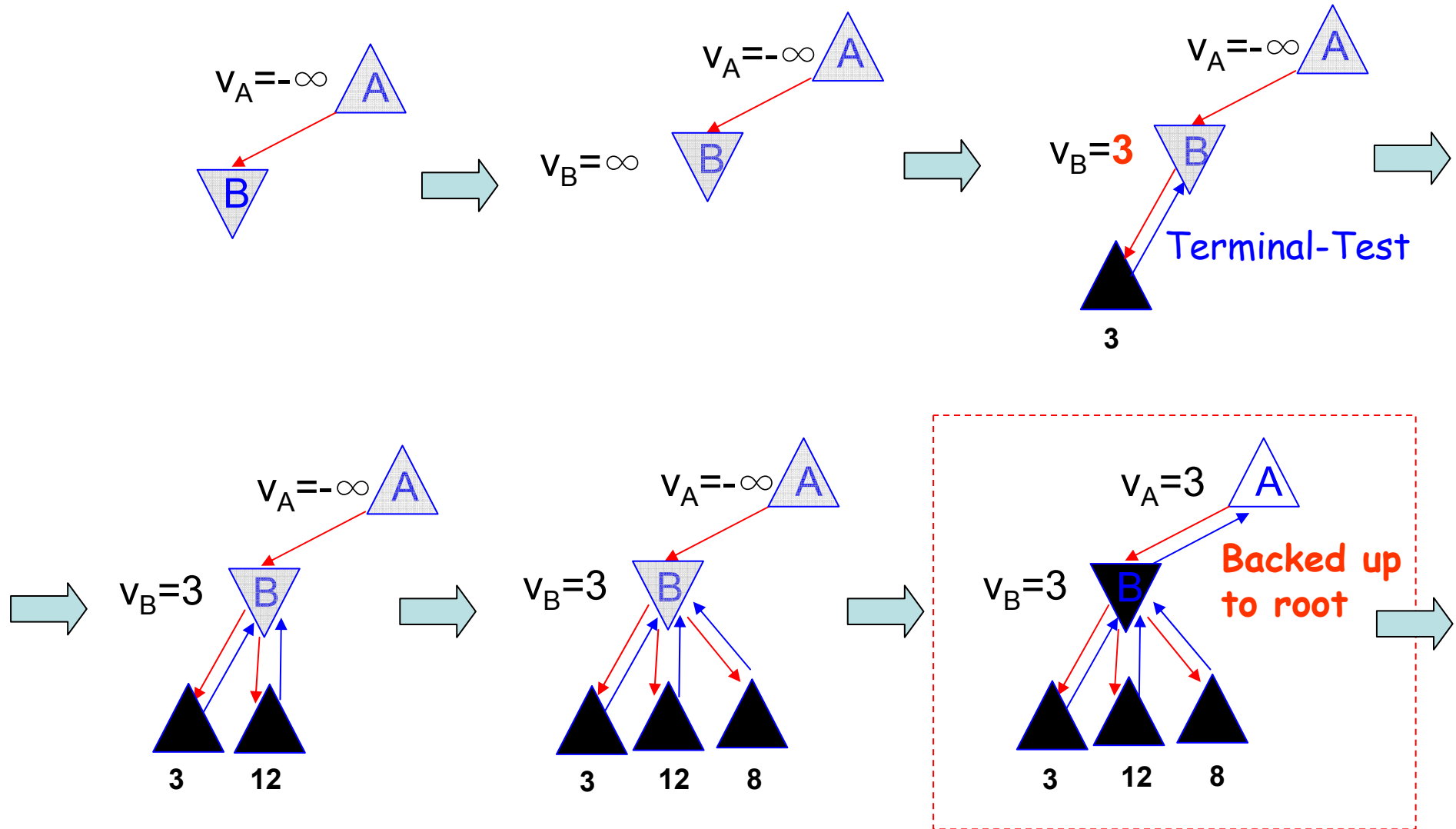

Minimax Search: Example (cont.)

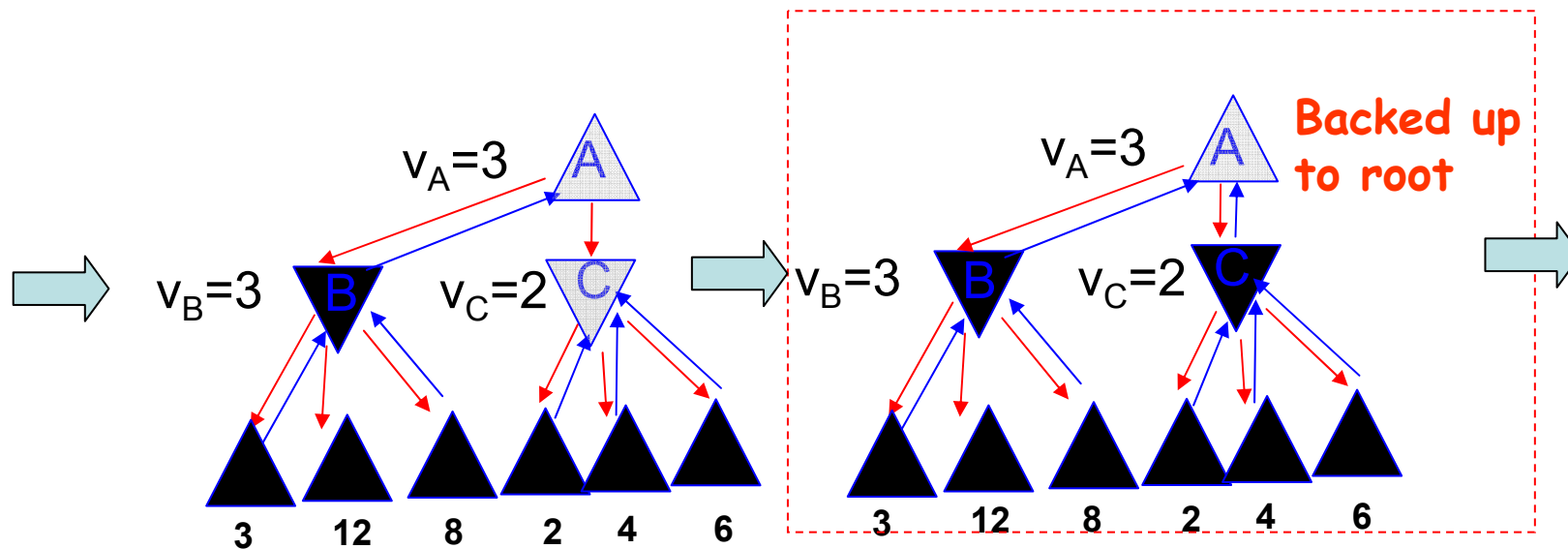
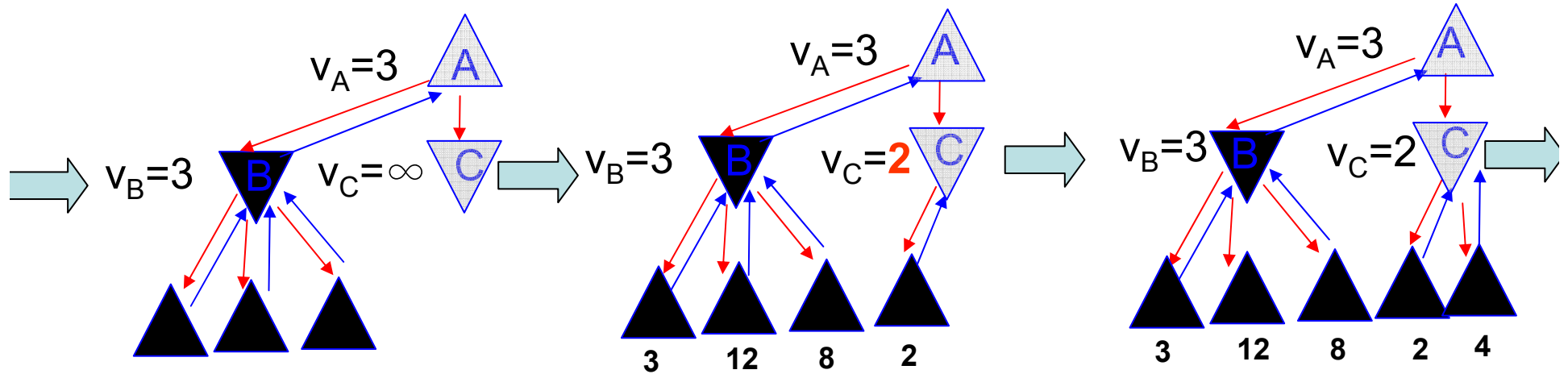

Minimax Search: Example (cont.)

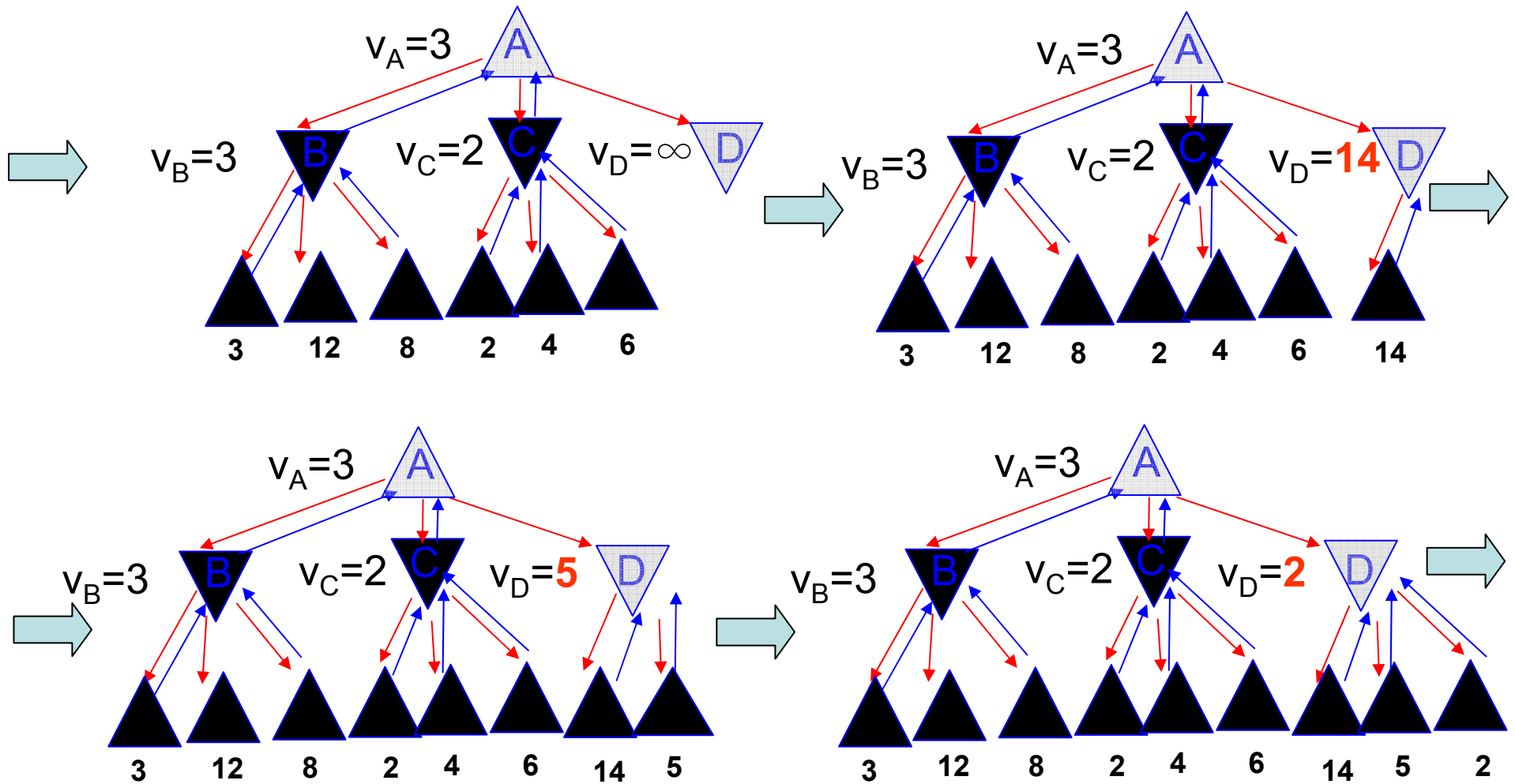

Minimax Search: Example (cont.)

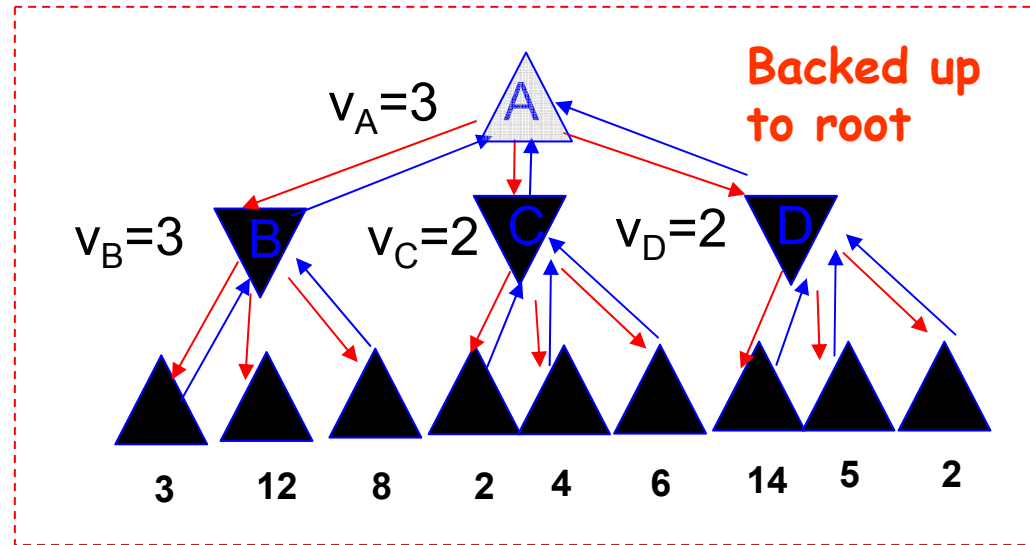
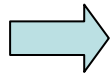

Minimax Search (cont.)

- Explanations of the Minimax Algorithm
 - A complete depth-first, recursive exploration of the game tree
 - The utility function is applied to each terminal state
 - The utility (min or max values) of internal tree nodes are calculated and then backed up through the tree as the recursion unwind
 - At the root, MAX chooses the move leading to the highest utility

Properties of Minimax Search

- Is complete if tree is finite
- Is optimal if the opponent acts optimally
- Time complexity: $O(b^m)$
 - m : the maximum depth of the tree
- Space complexity: $O(bm)$ or $O(m)$ (when successors generated one at a time)

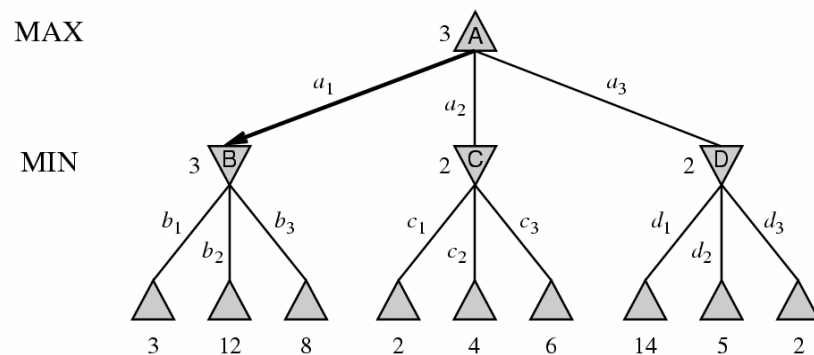

For chess, $b \approx 35$, $m \approx 100$ for "reasonable" games
I.e., exact solution is completely infeasible

Optimal Decisions in Multiplayer Games

- Extend the minimax idea to multiplayer games
- Replace the single value for each node with a vector of values (utility vector)

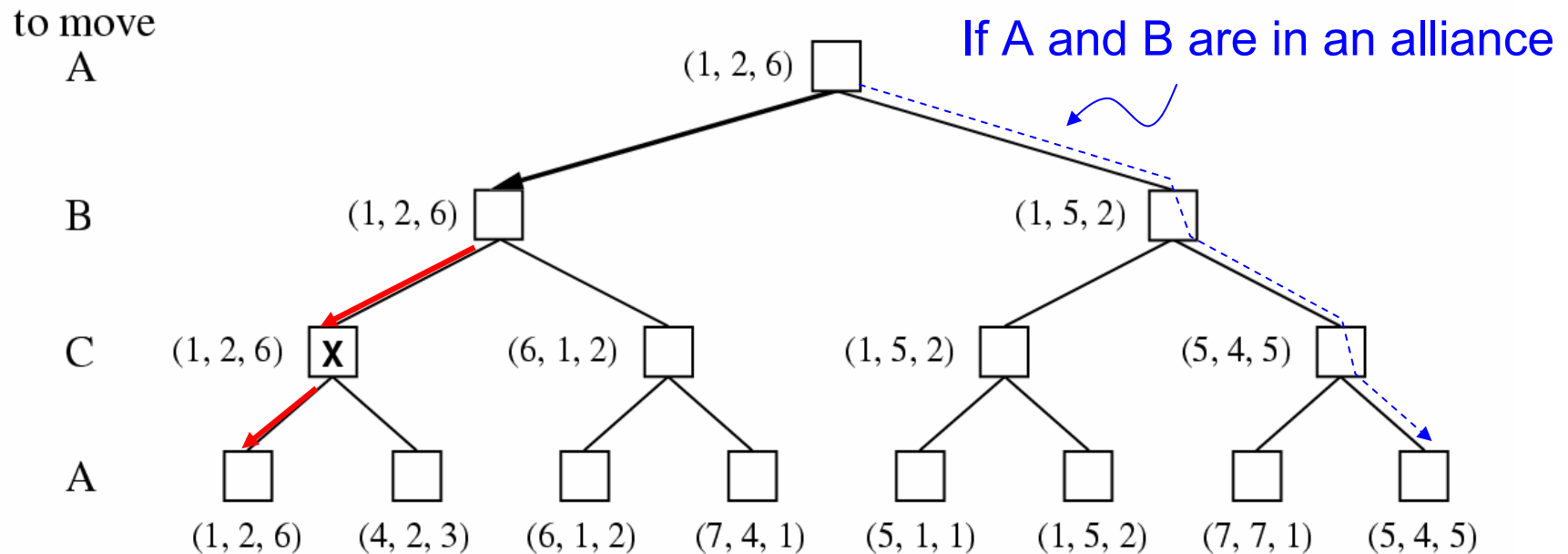

- Alliances among players would be involved sometimes
 - E.g., A and B form an alliance to attack C

$\alpha - \beta$ Pruning

- The problem with minimax search
 - The number of nodes to examine is exponential in the number of moves
- $\alpha - \beta$ pruning
 - Applied to the minimax tree
 - Return the same moves as minimax would, but prune away branches that can't possibly influence the final decision
- α : the value of best (highest-value) choice so far in search of MAX
- β : the value of best (lowest-value) choice so far in search of MIN

$\alpha - \beta$ Pruning (cont.)

- Example

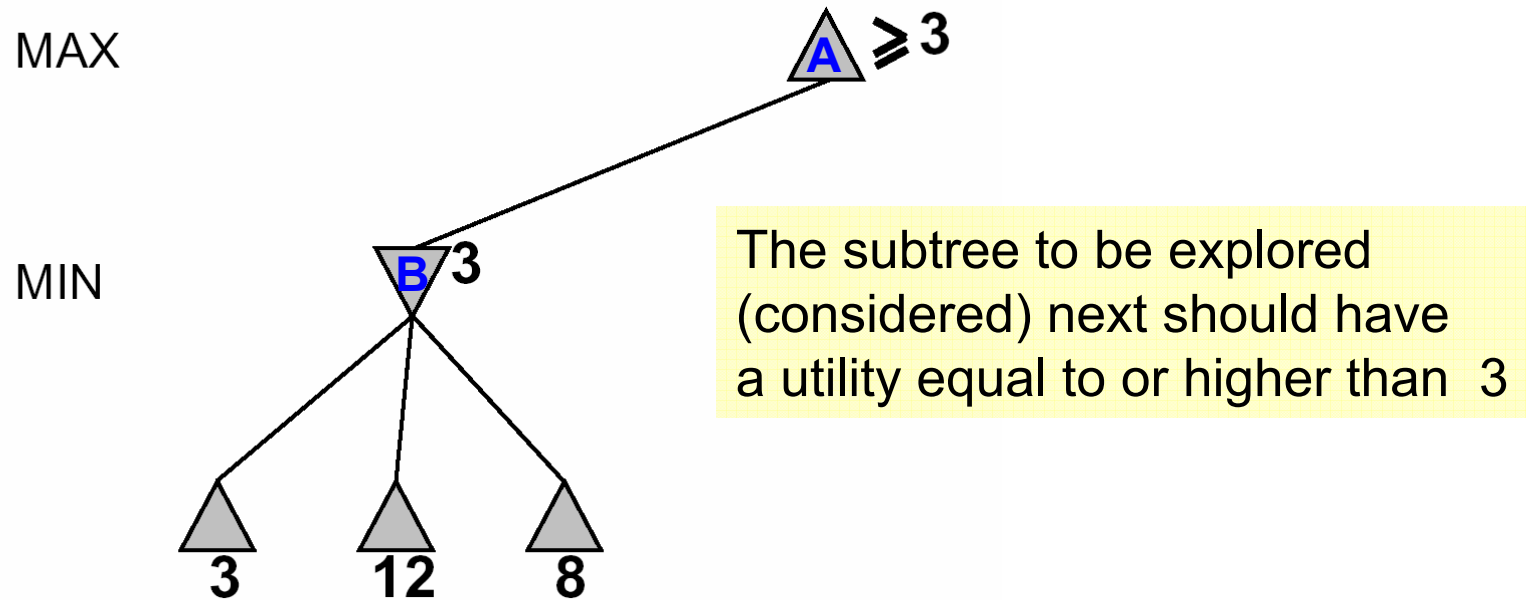

$\alpha - \beta$ Pruning (cont.)

- Example

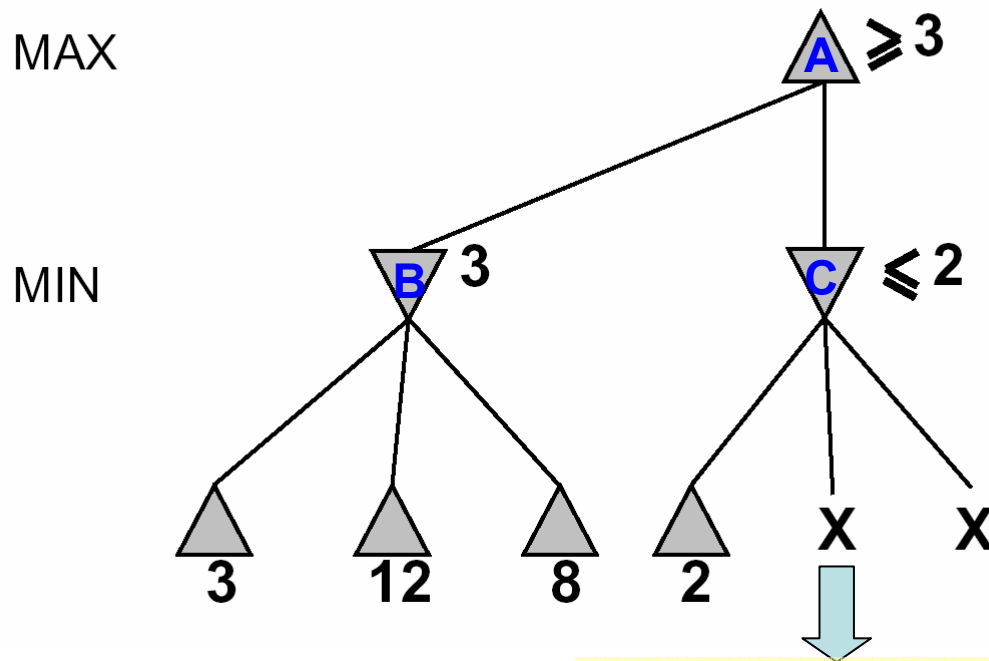

The utility of this subtree will be no more than 2 (lower than current α), so the remaining children can be pruned

$\alpha - \beta$ Pruning (cont.)

- Example

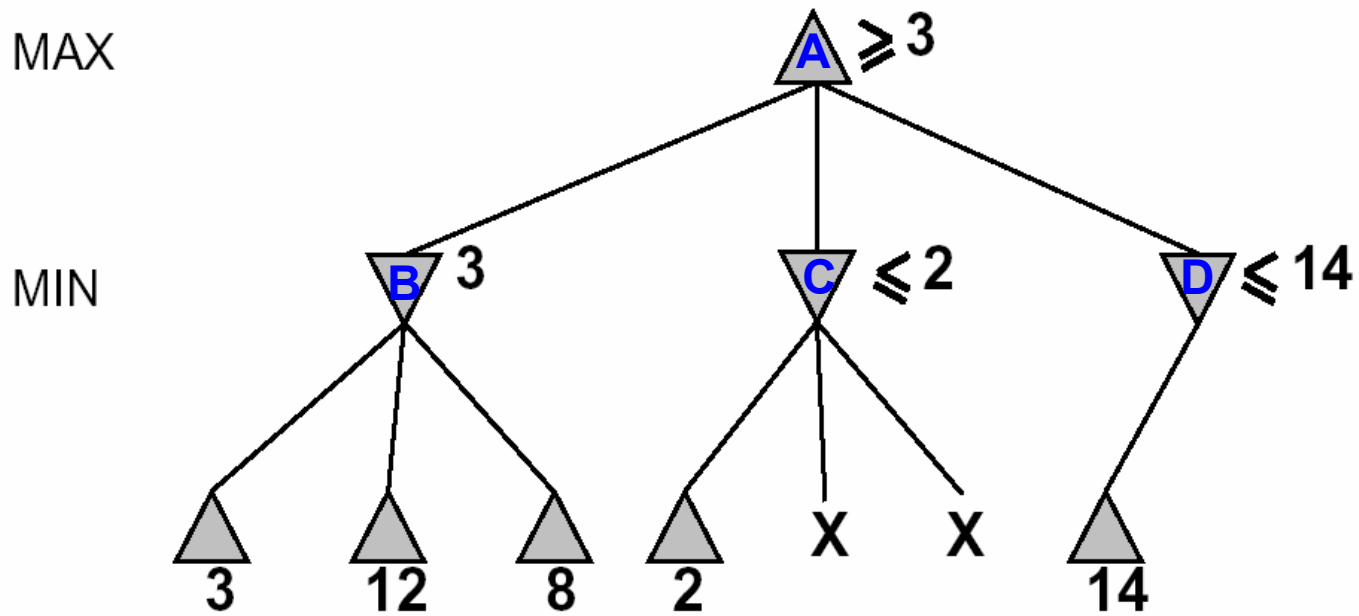

$\alpha - \beta$ Pruning (cont.)

- Example

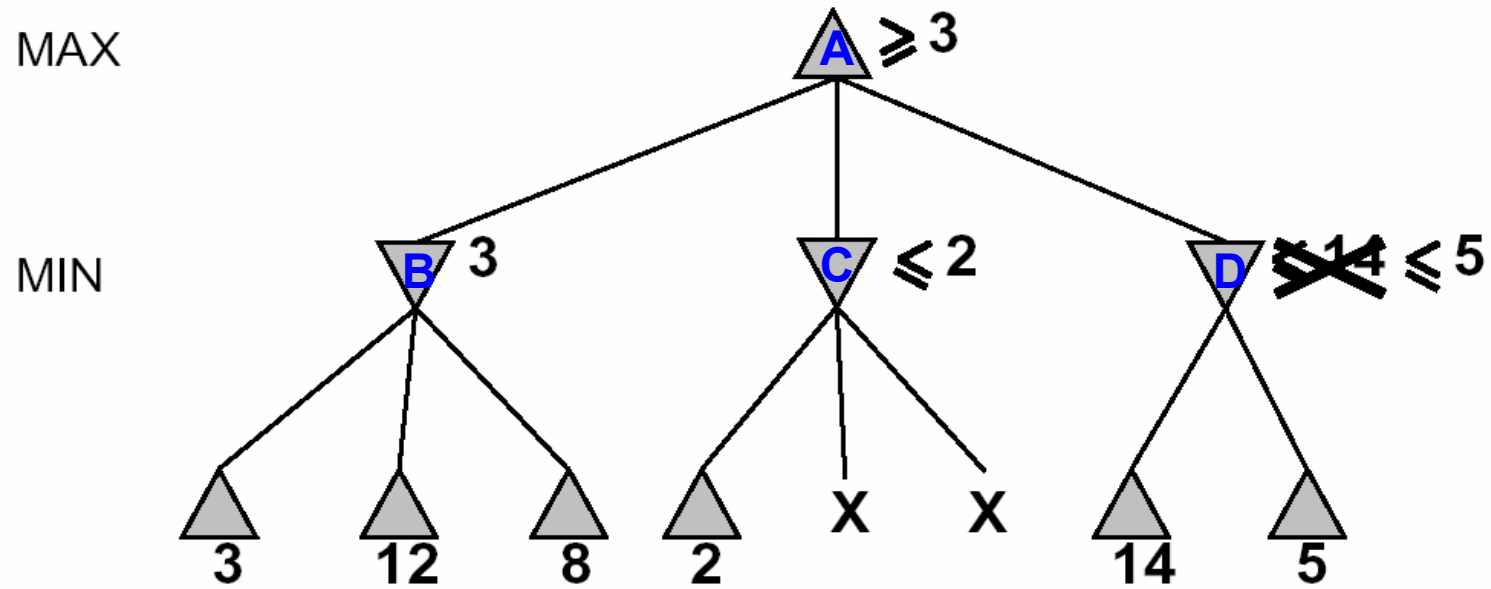

$\alpha - \beta$ Pruning (cont.)

- Example

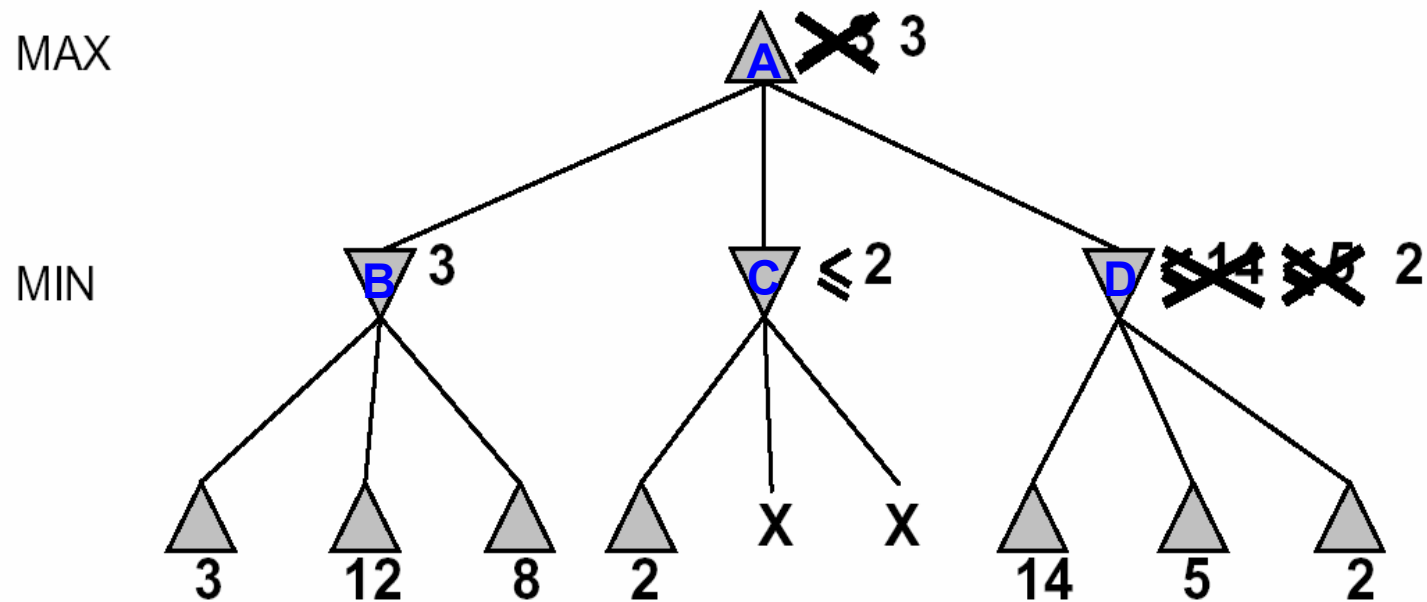

Can't prune any successors of D at all because the worst successors of D have been generated first

$\alpha - \beta$ Pruning (cont.)

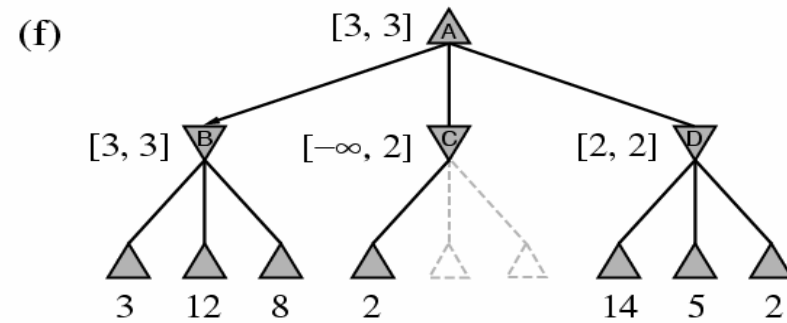
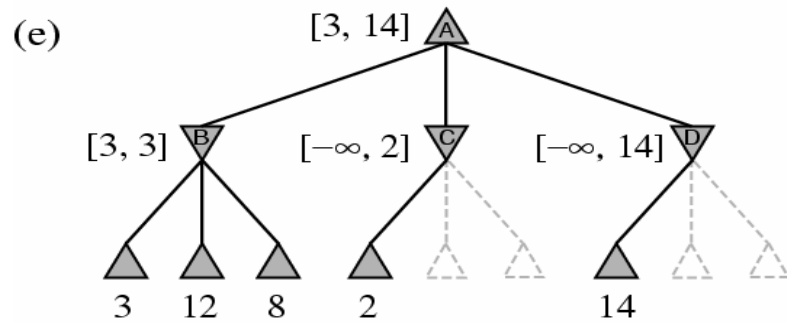
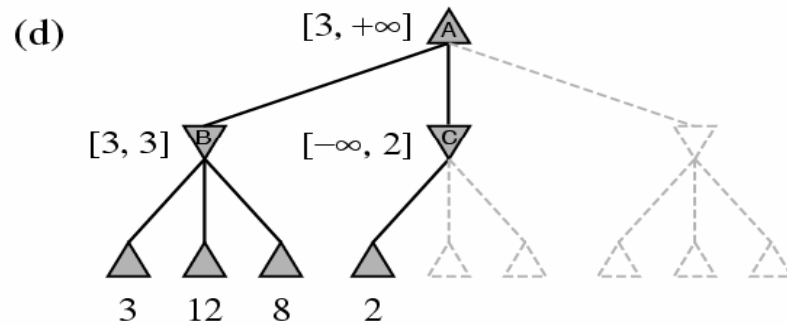
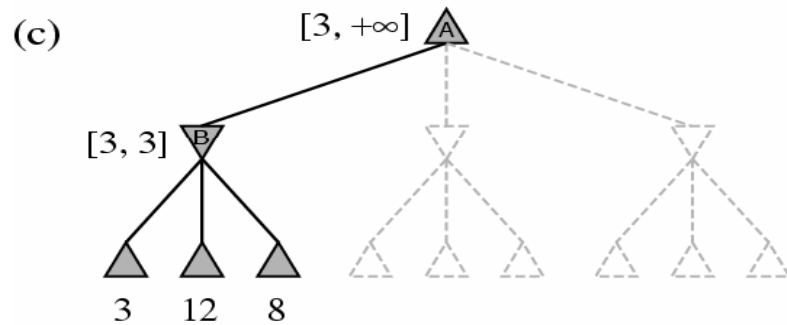
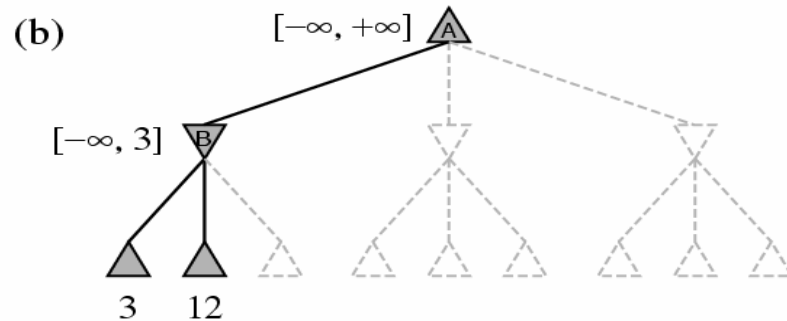
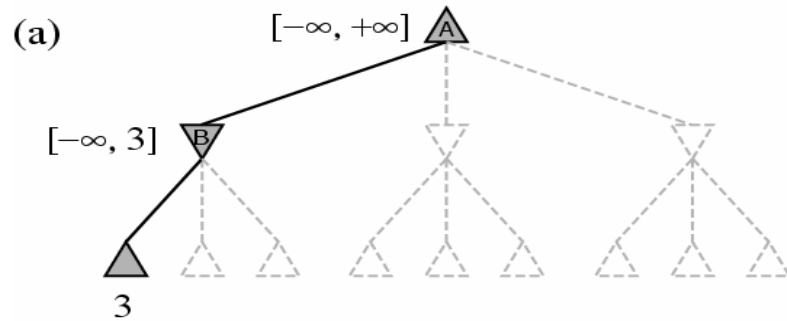

$\alpha - \beta$ Pruning (cont.)

$$\begin{aligned}\text{Minmax-Value}(\text{root}) &= \max(\min(3,12,8), \min(2, x, y), \min(14,5,2)) \\ &= \max(3, \min(2, x, y), 2) \\ &= \max(3, z, 2) \quad \text{where } z \leq 2 \\ &= 3\end{aligned}$$

- The value of the root are independent of the value of the pruned leaves x and y

Tree for Tic-Tac-Toe (cont.)

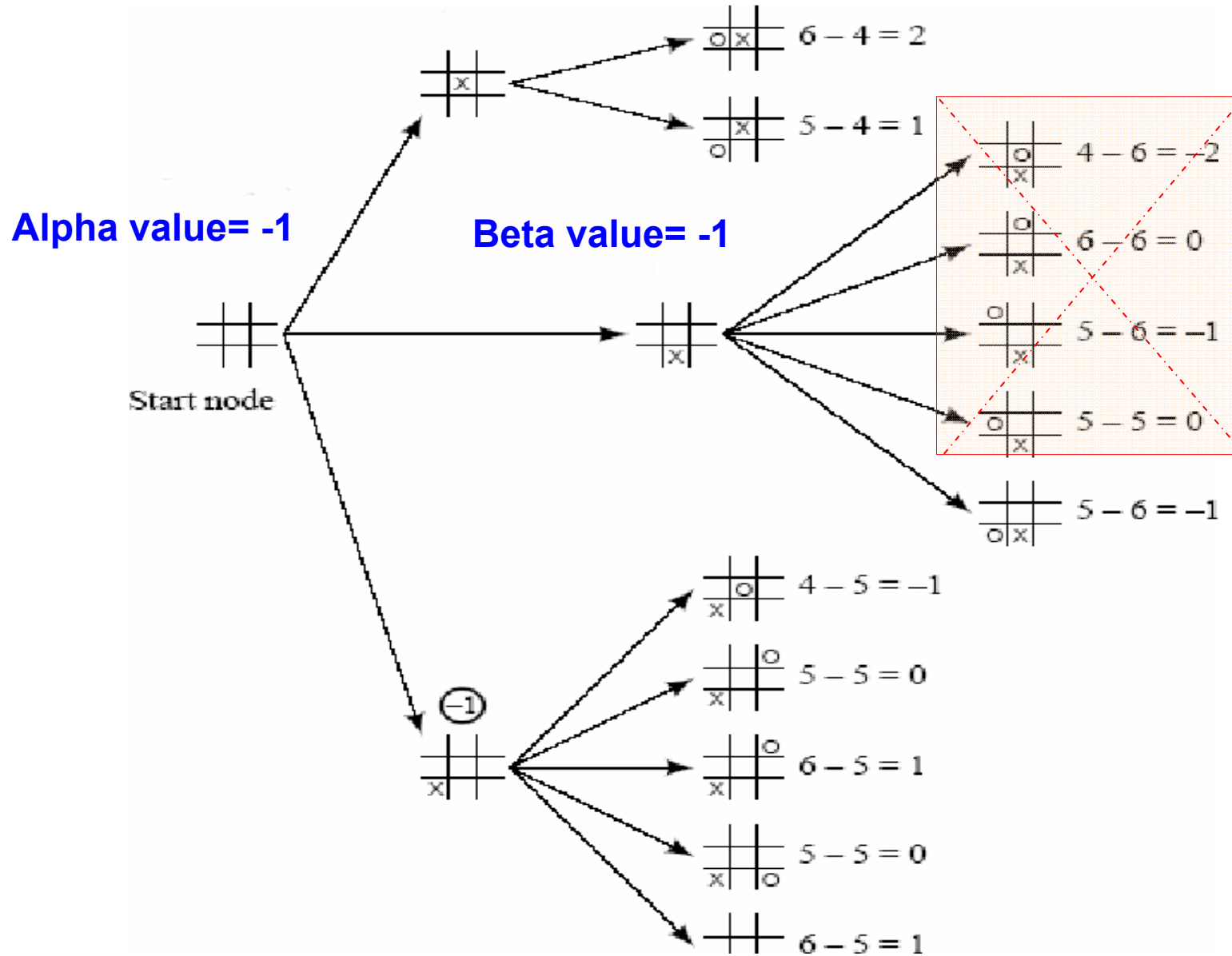

$\alpha - \beta$ Pruning (cont.)

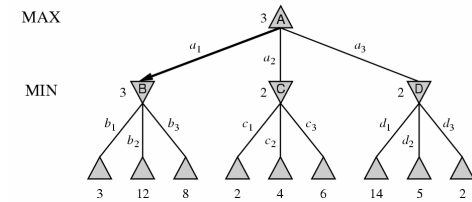

- Algorithm

function ALPHA-BETA-SEARCH(*state*) **returns** an action

inputs: *state*, current state in game

$v \leftarrow \text{MAX-VALUE}(\text{state}, -\infty, +\infty)$

return the *action* in SUCCESSORS(*state*) with value v

function MAX-VALUE(*state*, α , β) **returns** a utility value

inputs: *state*, current state in game

α , the value of the best alternative for MAX along the path to *state*

β , the value of the best alternative for MIN along the path to *state*

if TERMINAL-TEST(*state*) **then return** UTILITY(*state*)

$v \leftarrow -\infty$

for a, s in SUCCESSORS(*state*) **do**

$v \leftarrow \text{MAX}(v, \text{MIN-VALUE}(s, \alpha, \beta))$

if $v \geq \beta$ **then return** v

$\alpha \leftarrow \text{MAX}(\alpha, v)$

return v

Pruning: If one of its children has value larger than that of its best MIN predecessor node, return immediately. (?)

For MAX Node

function MIN-VALUE(*state*, α , β) **returns** a utility value

inputs: *state*, current state in game

α , the value of the best alternative for MAX along the path to *state*

β , the value of the best alternative for MIN along the path to *state*

if TERMINAL-TEST(*state*) **then return** UTILITY(*state*)

$v \leftarrow +\infty$

for a, s in SUCCESSORS(*state*) **do**

$v \leftarrow \text{MIN}(v, \text{MAX-VALUE}(s, \alpha, \beta))$

if $v \leq \alpha$ **then return** v

$\beta \leftarrow \text{MIN}(\beta, v)$

return v

Pruning: If one of its children has value lower than that of its best MAX predecessor node, return immediately. (?)

For MIN Node

$\alpha - \beta$ Pruning (cont.)

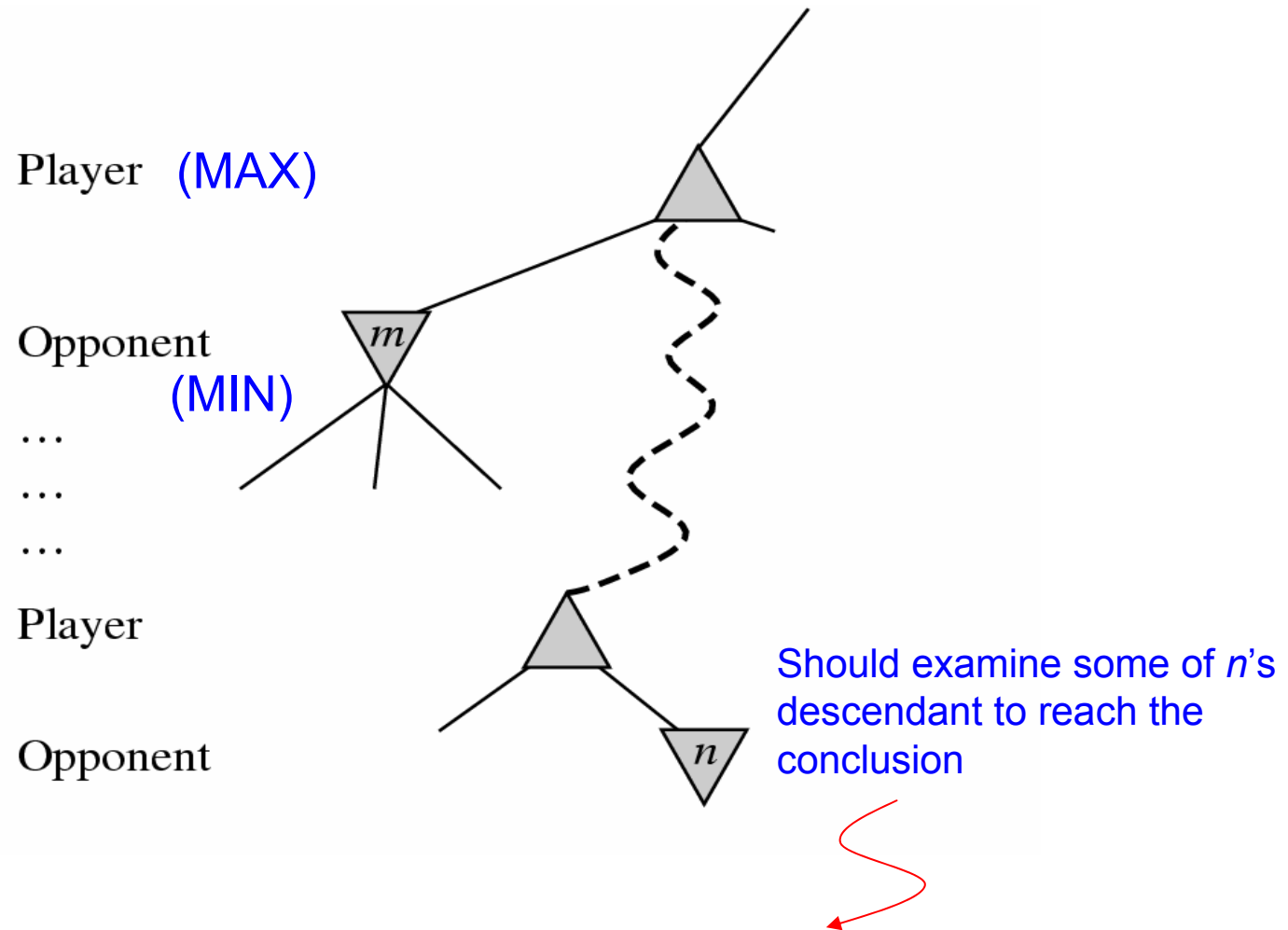

If m is better than n for Player (MAX), n will not be visited in play and can therefore be pruned

Properties of α - β Pruning

- Pruning does not affect final result
- The effectiveness of alpha-beta pruning is highly dependent on the order in which the successors are examined
 - Worthwhile to try to examine first the successors that are likely to be best
 - E.g., If the third successor “2” of node D has been generated first, the other two “14” and “5” can be pruned

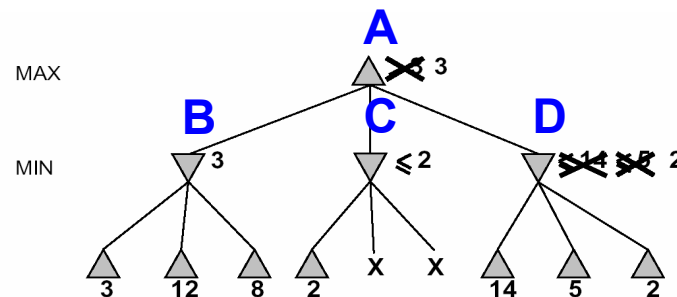

Properties of $\alpha - \beta$ Pruning (cont.)

- If “perfect ordering” can be achieved
 - Time complexity: $O(b^{m/2})$
 - Effective branching factor becomes: $b^{1/2}$
 - Can double the depth of search within the time limit
- If “random ordering”
 - Time complexity $\approx O(b^{3m/4})$ for moderate b
- Still have to search all the way to terminal states for at least a portion of the search space
 - The depth is usually not practical

Properties of $\alpha - \beta$ Pruning (cont.)

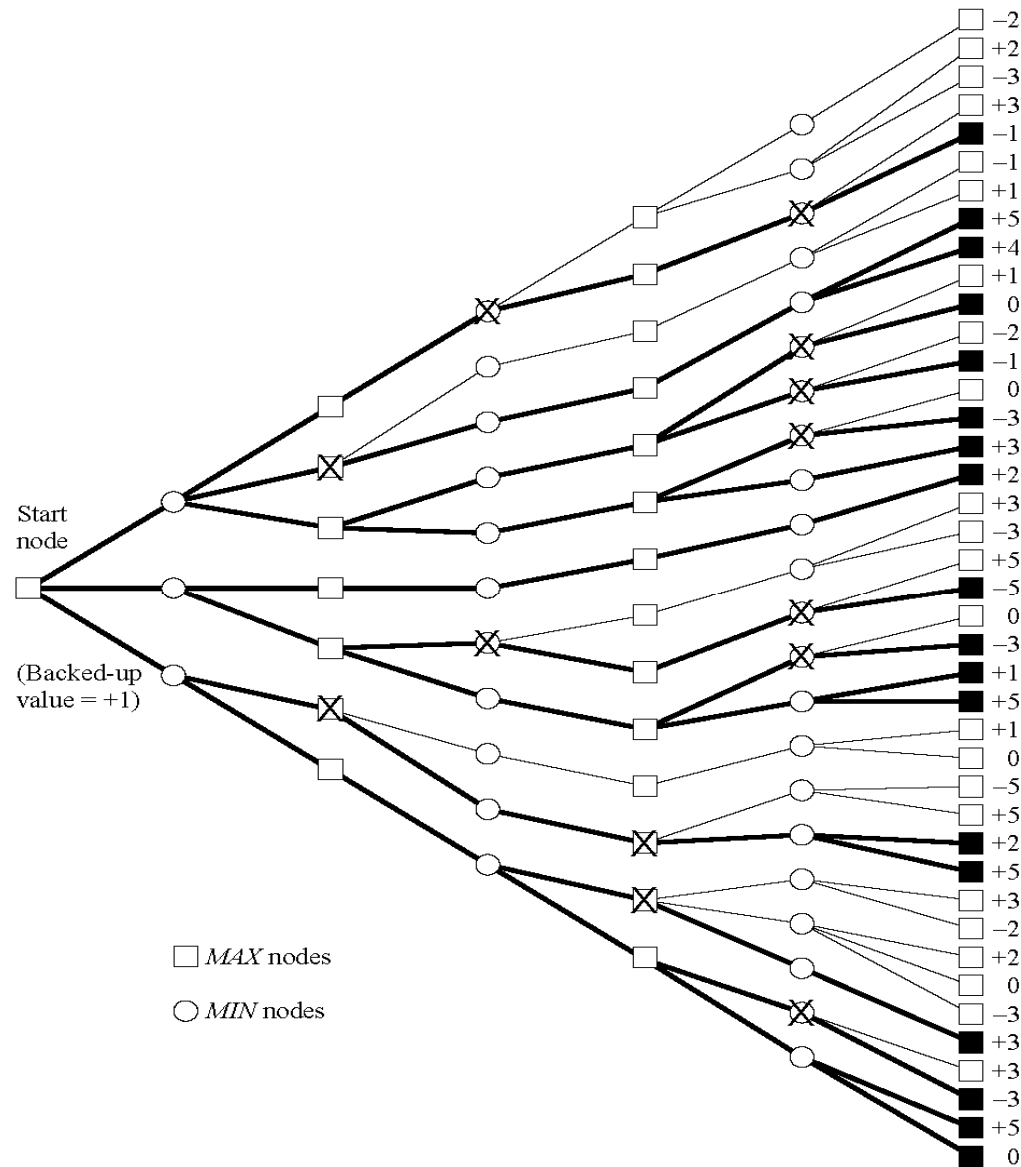

Imperfect, Real-Time Decisions

- Not feasible to search all the way to terminal states in per move
 - When minimax search is adopted alone, or even when alpha-beta pruning is additionally involved
 - Moves must be made in a reasonable amount of time
- Shannon (1960) said
 - “...programs should cut off search earlier and apply a heuristic function to states in the search, effectively turning nonterminal nodes into terminal leaves...”

Imperfect, Real-Time Decisions (cont.)

- Minimax or alpha-beta altered in two ways
 - A heuristic evaluation function *Eval* is used to replace the utility function
 - Give an estimate of the expected utility of the game from a given position
 - Judge the value of a position
 - A cutoff test is used to replace the terminal test
 - Decide when to apply *Eval*
 - Turn nonterminal nodes into terminal leaves
 - A fixed depth limit is used (often add *quiescence search*)

Evaluation Functions

- Criteria for good evaluation functions
 - Should order the terminal states in the same way as the true utility function
 - Avoid selecting suboptimal moves
 - Must not take too long to calculate
 - Time controls usually enforced
 - For nonterminal states, it should be strongly correlated with the actual chances of winning
 - Do not overestimate or underestimate too much
 - Chances here mean uncertainty, which is introduced by computational limits
 - A guess/prediction should be made

Evaluation Functions (cont.)

- **Method 1:** Most evaluation functions calculate and then combine various features of a state to give the estimation
 - E.g., the number of pawns possessed by each side in the chess game
 - Many states (with different board configurations) would have the same values of all features
 - States in the **same category** will win, draw, or lose proportionally/probabilistically

$$\underbrace{(0.72 \times +1)}_{\text{win}} + \underbrace{(0.20 \times -1)}_{\text{loss}} + \underbrace{(0.08 \times 0)}_{\text{draw}} = 0.52$$

- Too many categories required to calculate the expected values for evaluation functions, and hence too much experience required to estimate the probabilities

Evaluation Functions (cont.)

- **Method 2: Weighted linear function**
 - Directly compute separate numerical contributions from each feature and then combine them to find the total value for a state

$$\text{Eval}(s) = w_1 f_1(s) + w_2 f_2(s) + \dots + w_J f_J(s) = \sum_{j=1}^J w_j f_j(s)$$

The num. of each kind of piece on the board

weights can be learned via machine learning techniques

- Assumptions:
 1. features are independent on each other
 2. values of features won't change with time
- The material value for each piece in the chess game
 - E.g., a pawn has a value of 1, a bishop/knight for 3, a rook for 5, a queen for 9 etc.

Cutting Off Search

- When to call the heuristic evaluation function in order to appropriately cut off the search ?

if Cutoff-Test(*state*, *depth*) **then return** Eval(*state*)

- Replace the “Terminal-Test” line in the algorithm
- The amount of search is controlled by setting a fixed depth limit such that the time constraint will not be violated
- Bookkeeping for the current node’s depth is needed

Cutoff-Test(*state*, *depth*)

- Return *true* for all *depth* greater than some fixed depth *d*, and vice versa
 - Return *true* for all terminal states
- Iterative deepening search (IDS) can be applied here
 - Return the move selected by the deepest completed search

Cutting Off Search: Problems

- Suppose when the program has searched to the depth limit and reached the following position

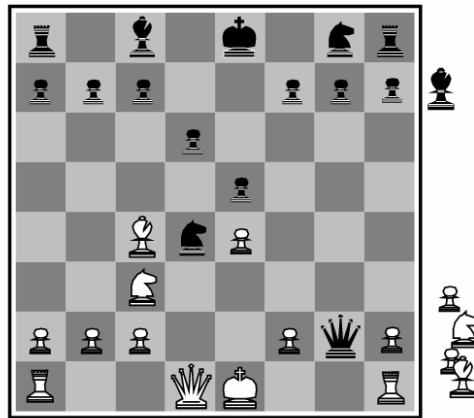

(a) White to move

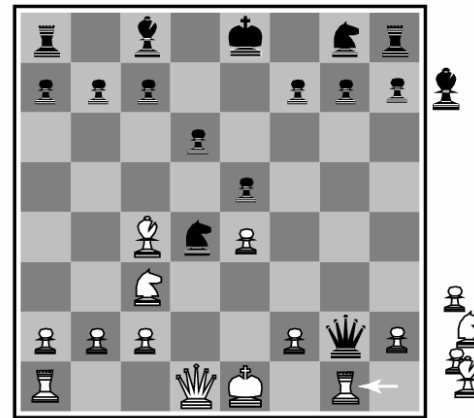

(b) White to move

- (a) Black an advantage of a knight and two pawns and will win the game
 - (b) Black will lose after white captures the queen
- A more sophisticated cutoff test (for quiescence) is needed !

Cutting Off Search: Quiescence

- A quiescent position is one which is unlikely to exhibit *wild swings* in value in the near future
- Nonquiescent positions can be expanded further until quiescent positions are reached
 - Called quiescence search
 - Search for certain types of moves
 - E.g., search for “capture moves”

Deterministic Games in Practices

- Checkers
 - 1994, the computer defeated the human world champion
- Chess
 - 1997, Deep blue defeated the human world champion
 - Can seek 200 million positions per sec (almost 40 plies)
- Othello
 - Computers are superior
- Go
 - Humans are superior

Nondeterministic Games: Backgammon

西洋雙陸棋

- Games that combine luck and skill
 - Dice are rolled at the beginning of a player's turn to determine the legal moves
 - E.g., Backgammon

home board of black

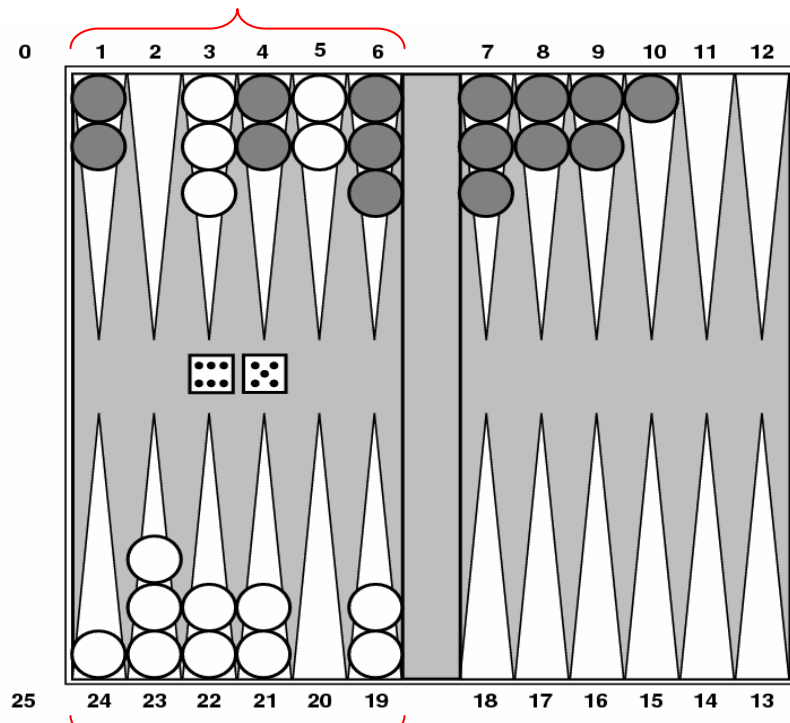

home board of white

1. **Goal of the game:** move all one's pieces off the board
 2. White moves clockwise toward 25
Black moves counterclockwise toward 0
 3. A piece can move to any position unless there are multiple opponent pieces there
 4. If the position to be move to has only one opponent, the opponent will be captured and restarted over
 5. When one's all pieces are in his home board, the pieces can be moved off the board
- ...

When white has rolled 6-5, it must choose among four legal moves:
(5-10,5-11),(5-11,19-24),(5-10,10-16) and
(5-11,11-16)

Nondeterministic Games: Backgammon (cont.)

- A game tree includes chance nodes

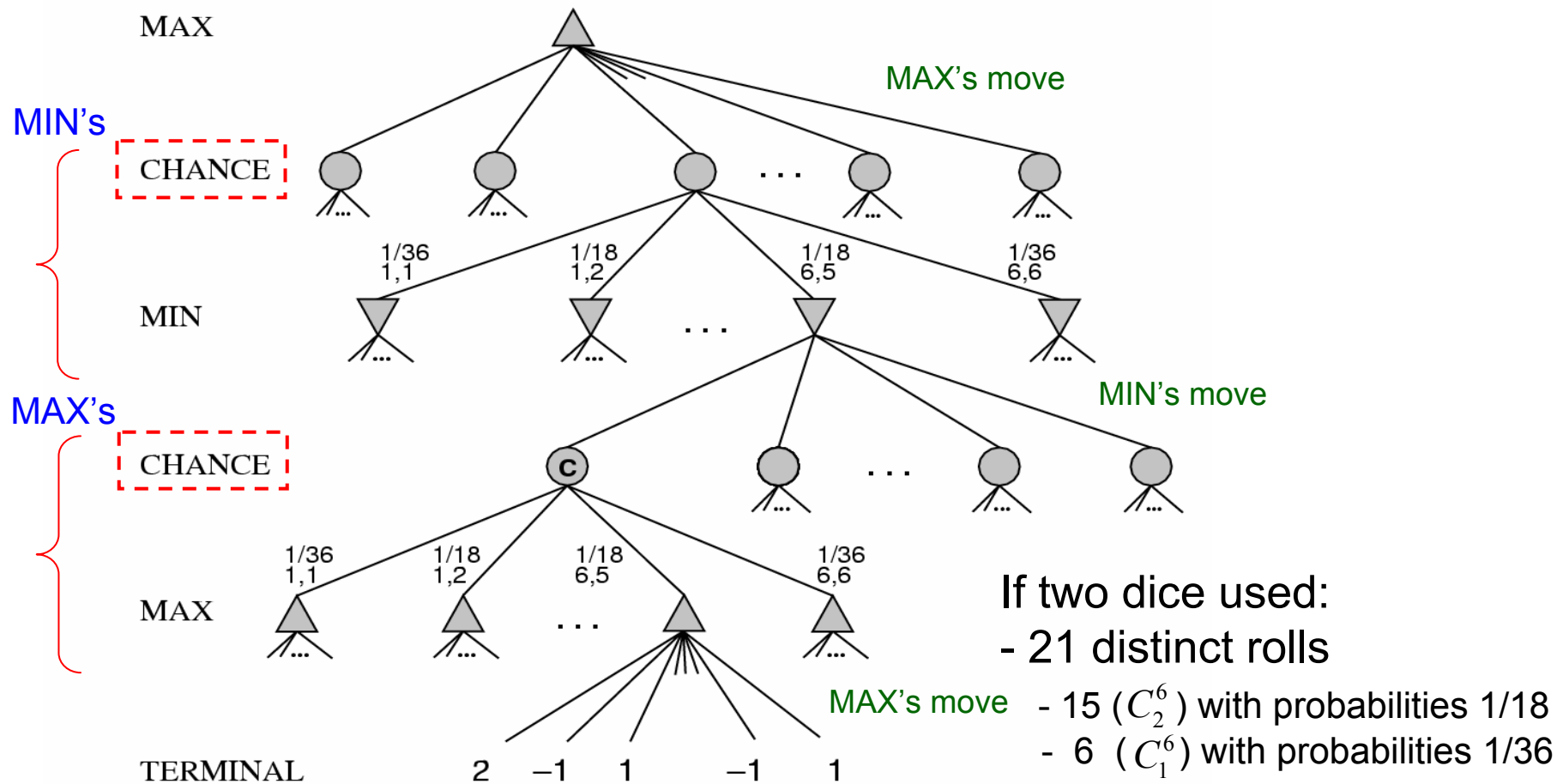

Nondeterministic Games in General

- Chance introduced by dice, card-shuffling
 - E.g., a simplified example with coin-flipping

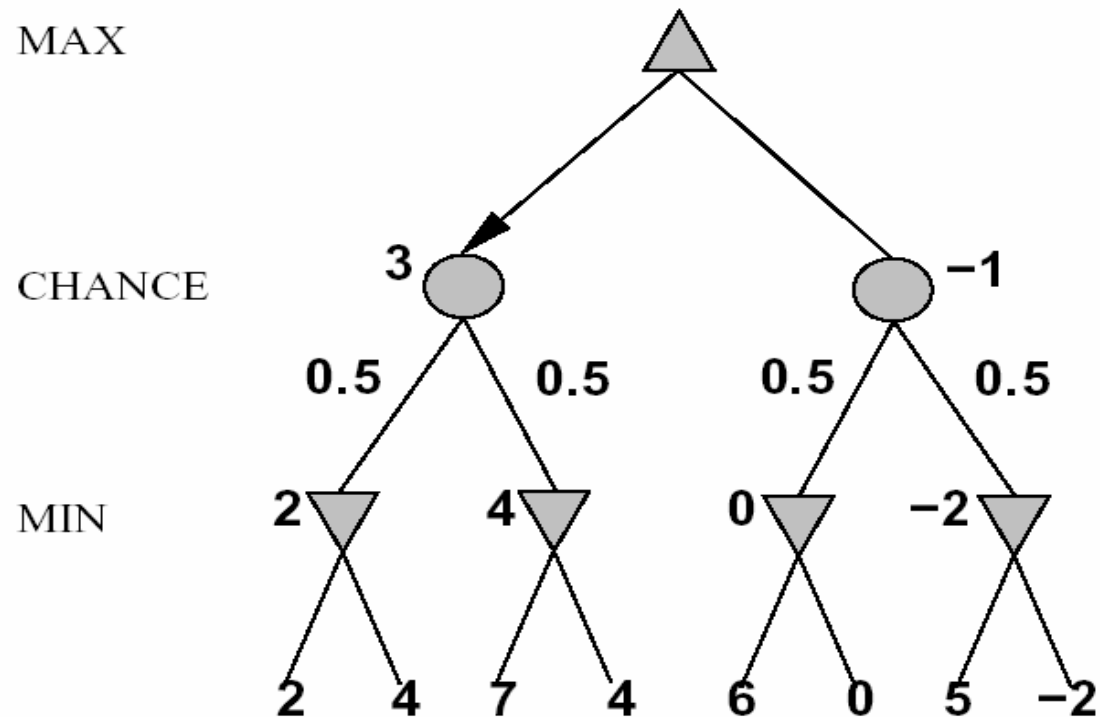

Algorithm for Nondeterministic Games

- Expectiminimax gives perfect play
 - Just like minimax, except chance nodes must be also handled

expectiminimax(n) =

$$\left\{ \begin{array}{ll} \text{Utility}(n) & \text{if } n \text{ is a terminal state} \\ \max_{s \in \text{Successor}(n)} \text{expectiminimax}(s) & \text{if } n \text{ is a MAX node} \\ \min_{s \in \text{Successor}(n)} \text{expectiminimax}(s) & \text{if } n \text{ is a MIN node} \\ \sum_{s \in \text{Successor}(n)} P(s) \cdot \text{expectiminimax}(s) & \text{if } n \text{ is a chance node} \end{array} \right.$$

Pruning in Nondeterministic Game Trees

- A version of $\alpha - \beta$ pruning is possible

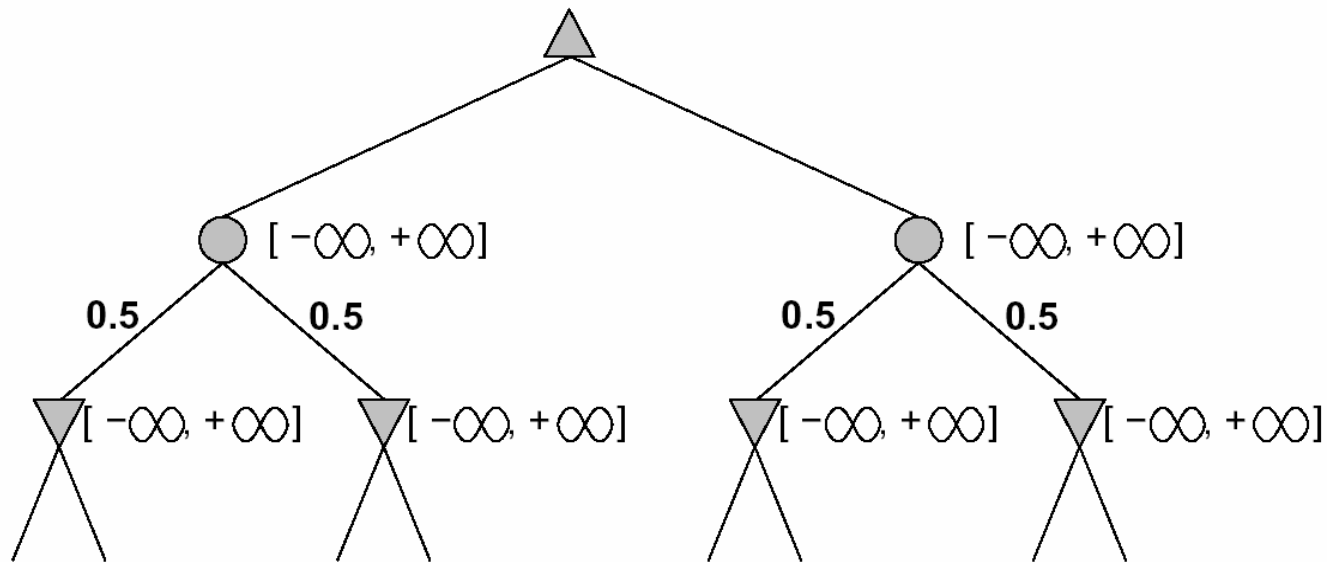

Pruning in Nondeterministic Game Trees (cont.)

- A version of $\alpha - \beta$ pruning is possible

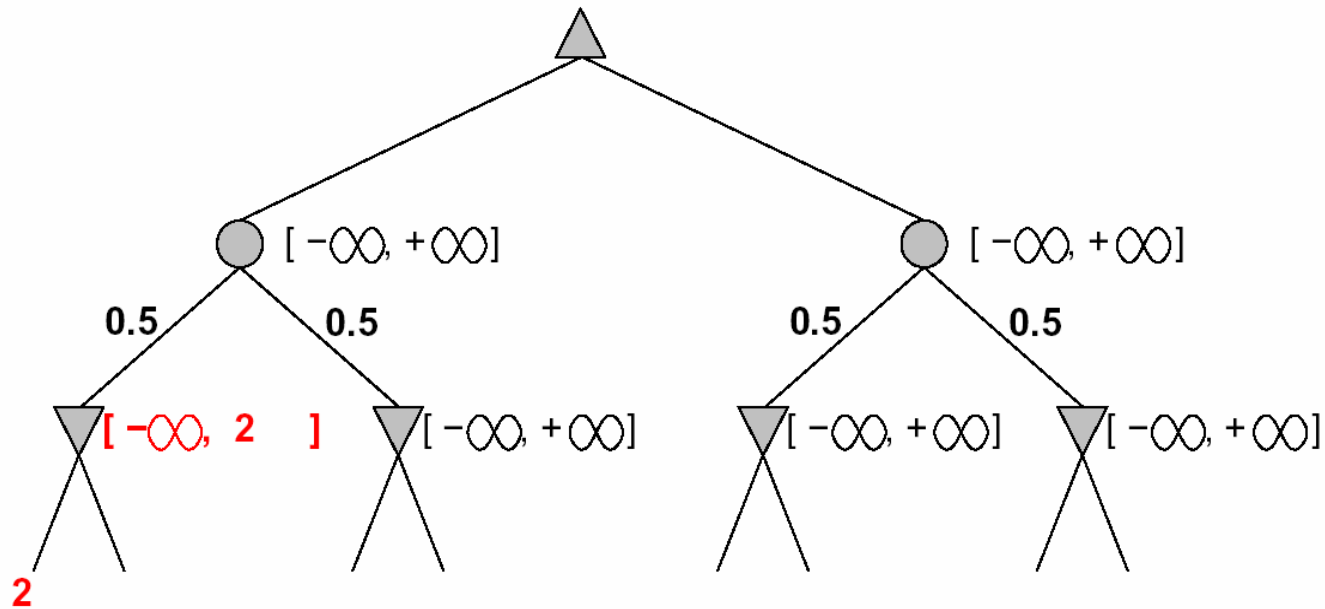

Pruning in Nondeterministic Game Trees (cont.)

- A version of $\alpha - \beta$ pruning is possible

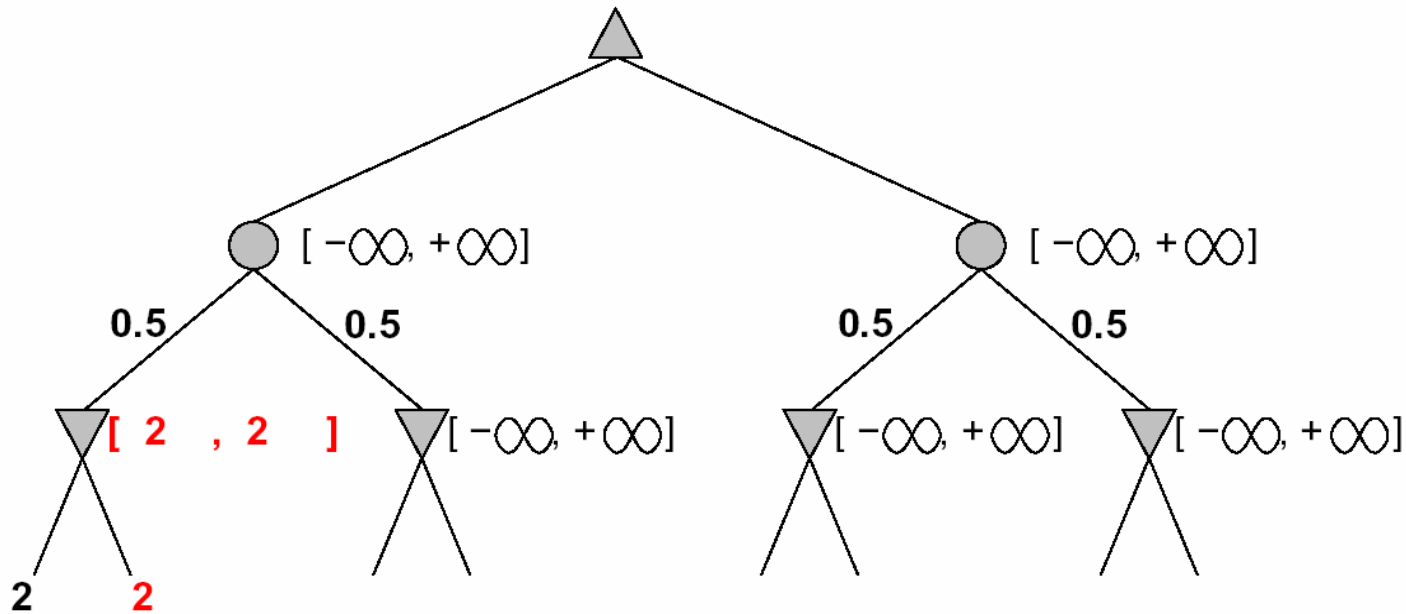

Pruning in Nondeterministic Game Trees (cont.)

- A version of $\alpha - \beta$ pruning is possible

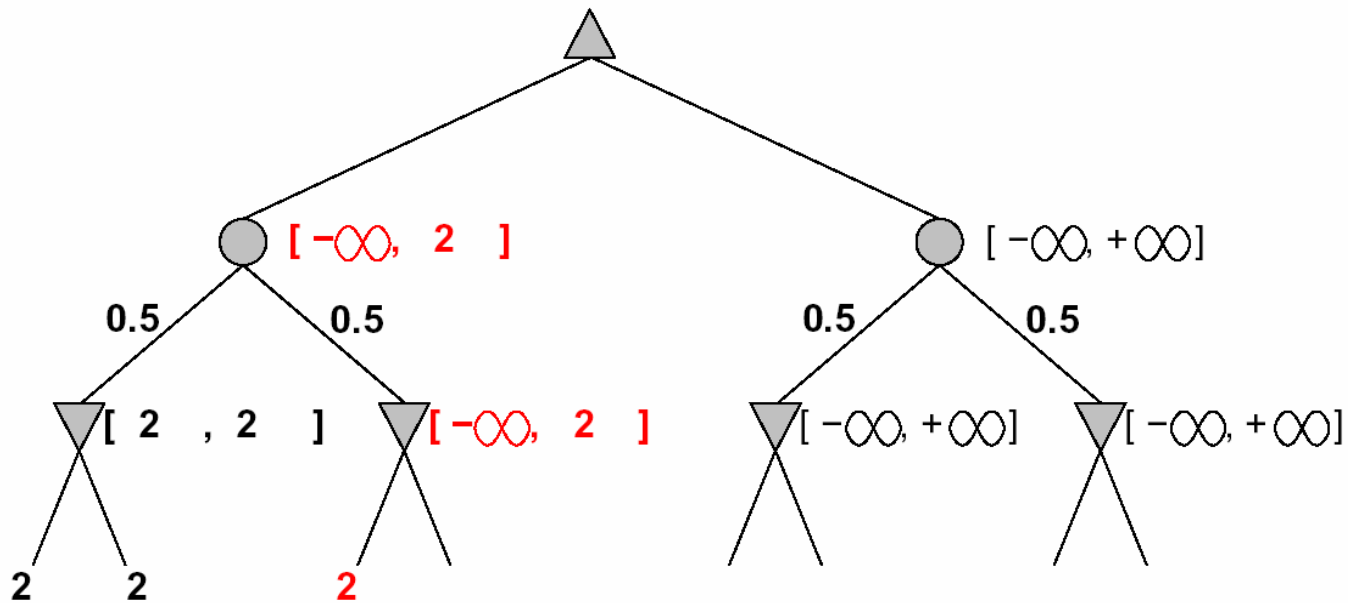

Pruning in Nondeterministic Game Trees (cont.)

- A version of $\alpha - \beta$ pruning is possible

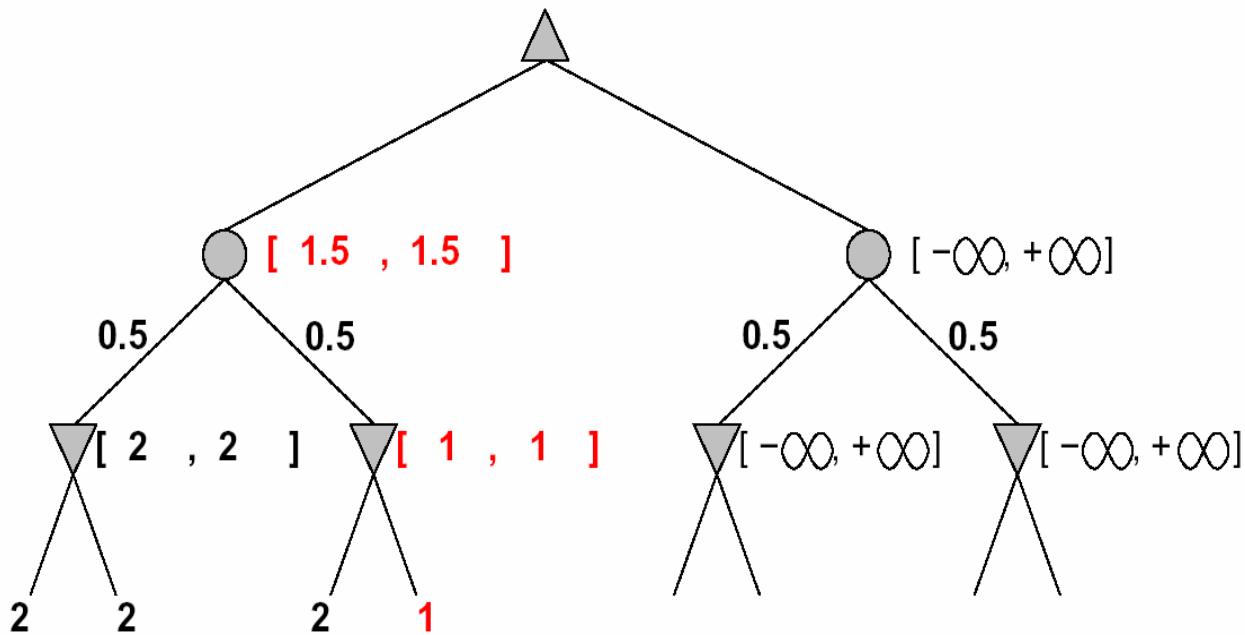

Pruning in Nondeterministic Game Trees (cont.)

- A version of $\alpha - \beta$ pruning is possible

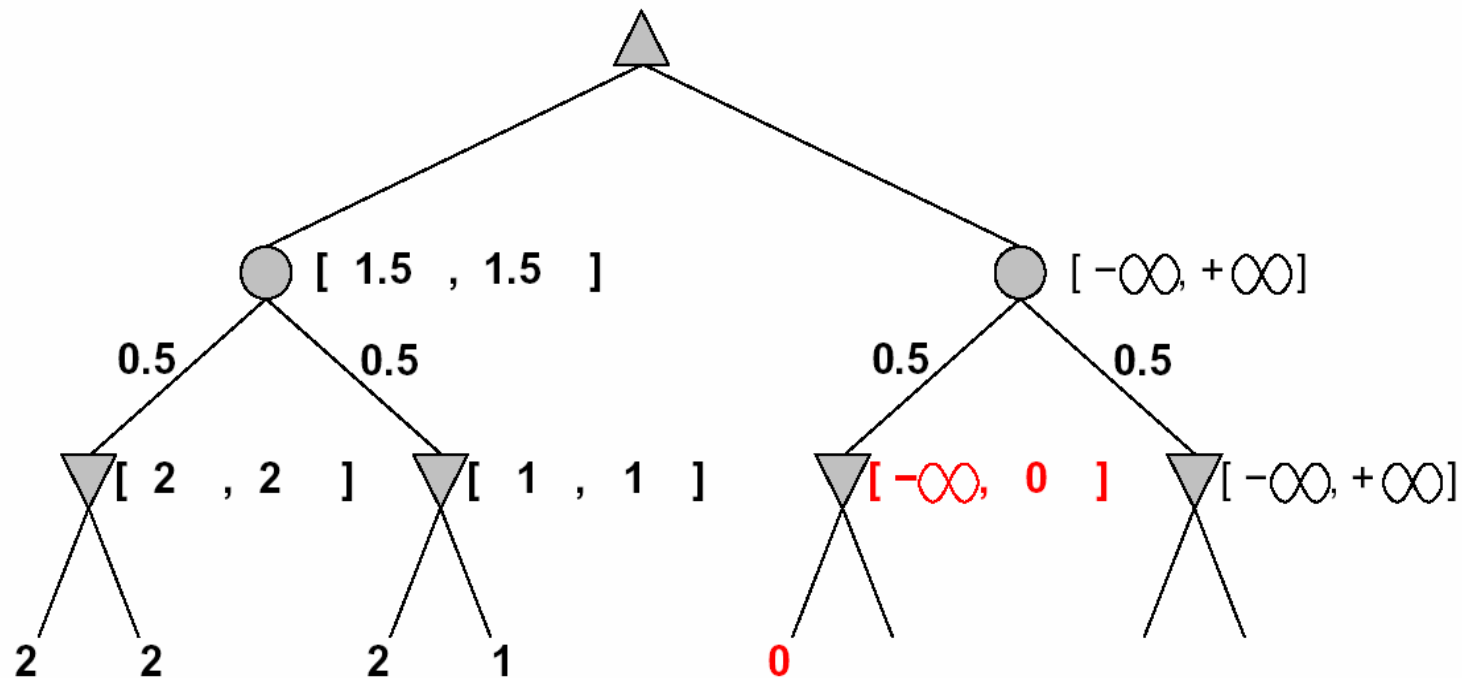

Pruning in Nondeterministic Game Trees (cont.)

- A version of $\alpha - \beta$ pruning is possible

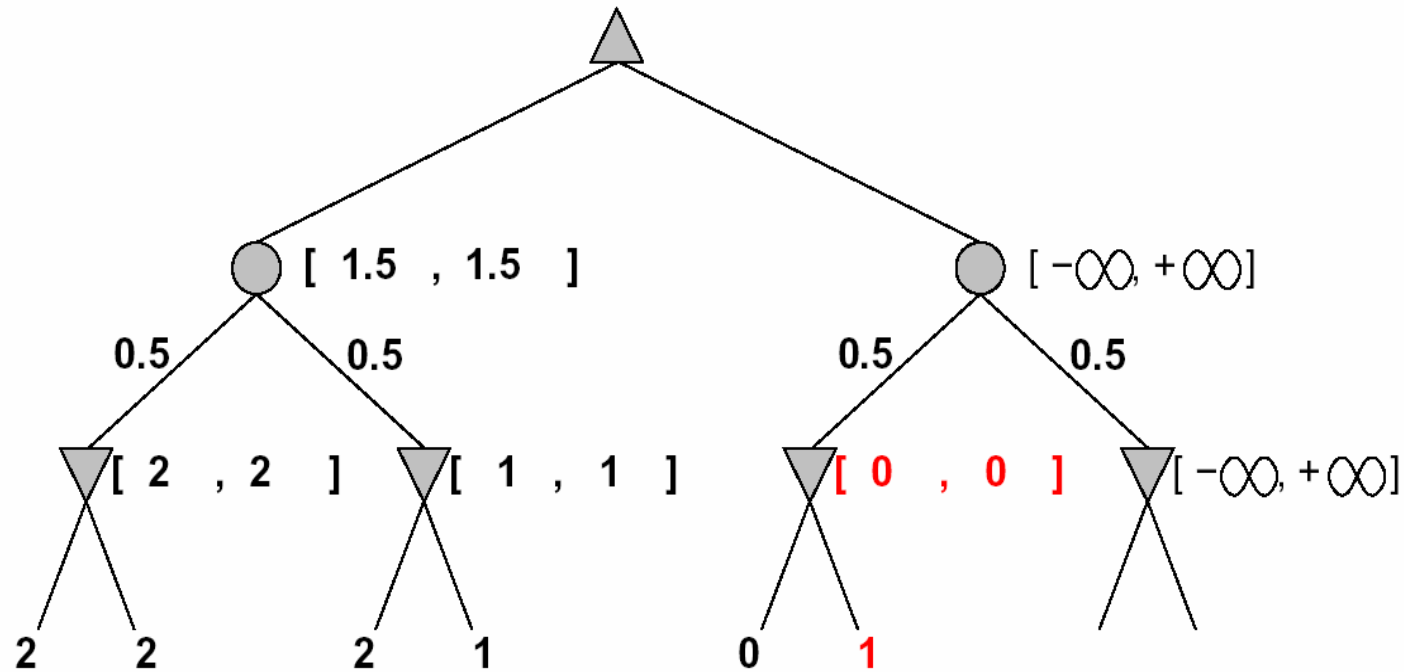

Pruning in Nondeterministic Game Trees (cont.)

- A version of $\alpha - \beta$ pruning is possible

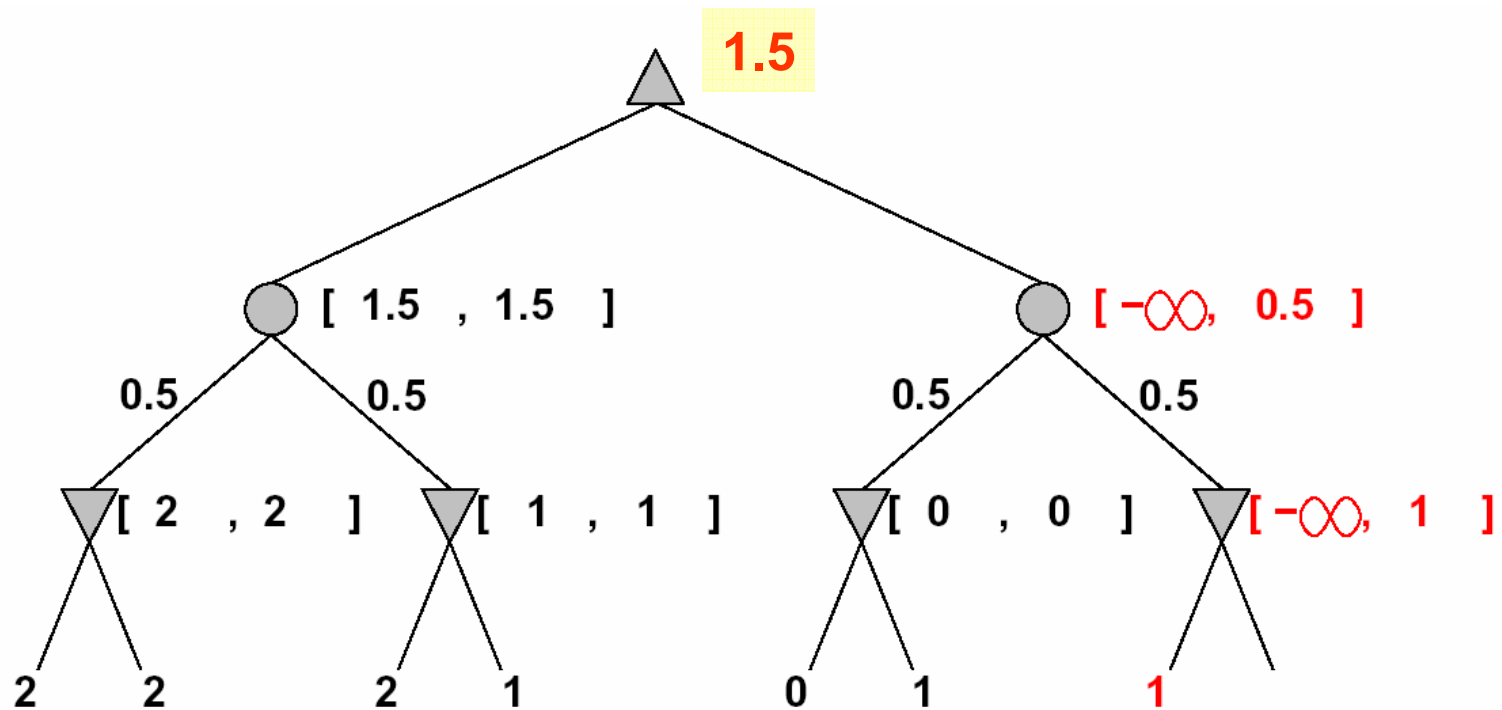

Pruning with Bounds

- More pruning if we can bound the leaf values

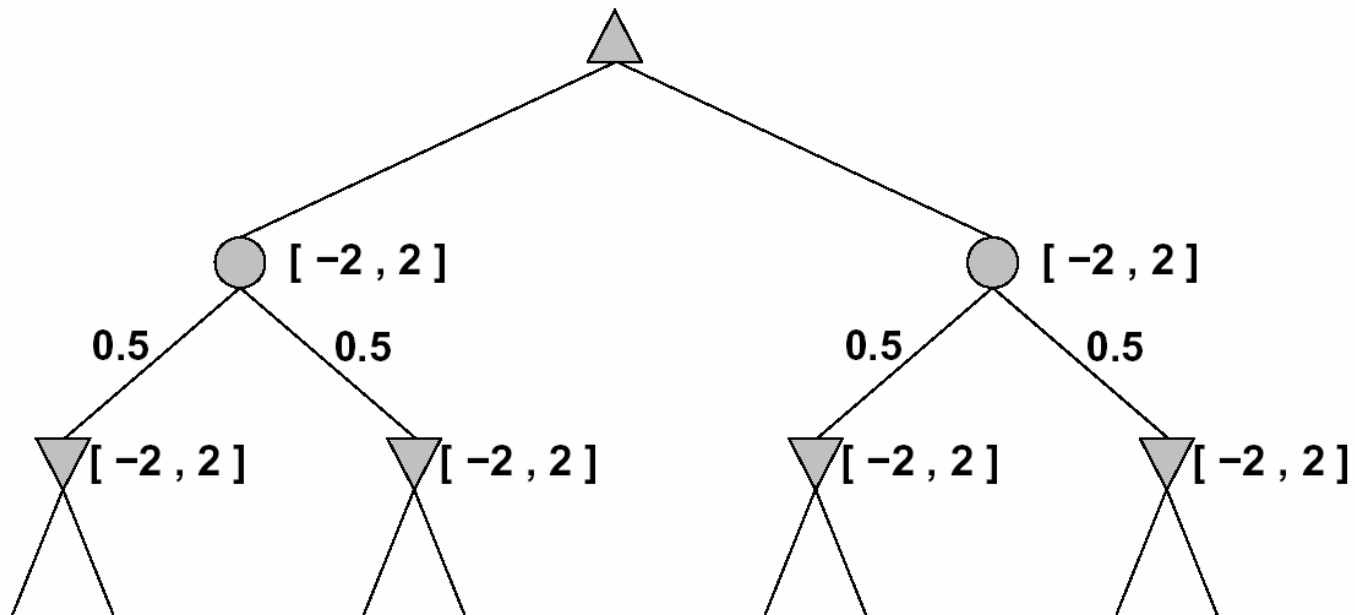

Pruning with Bounds (cont.)

- More pruning if we can bound the leaf values

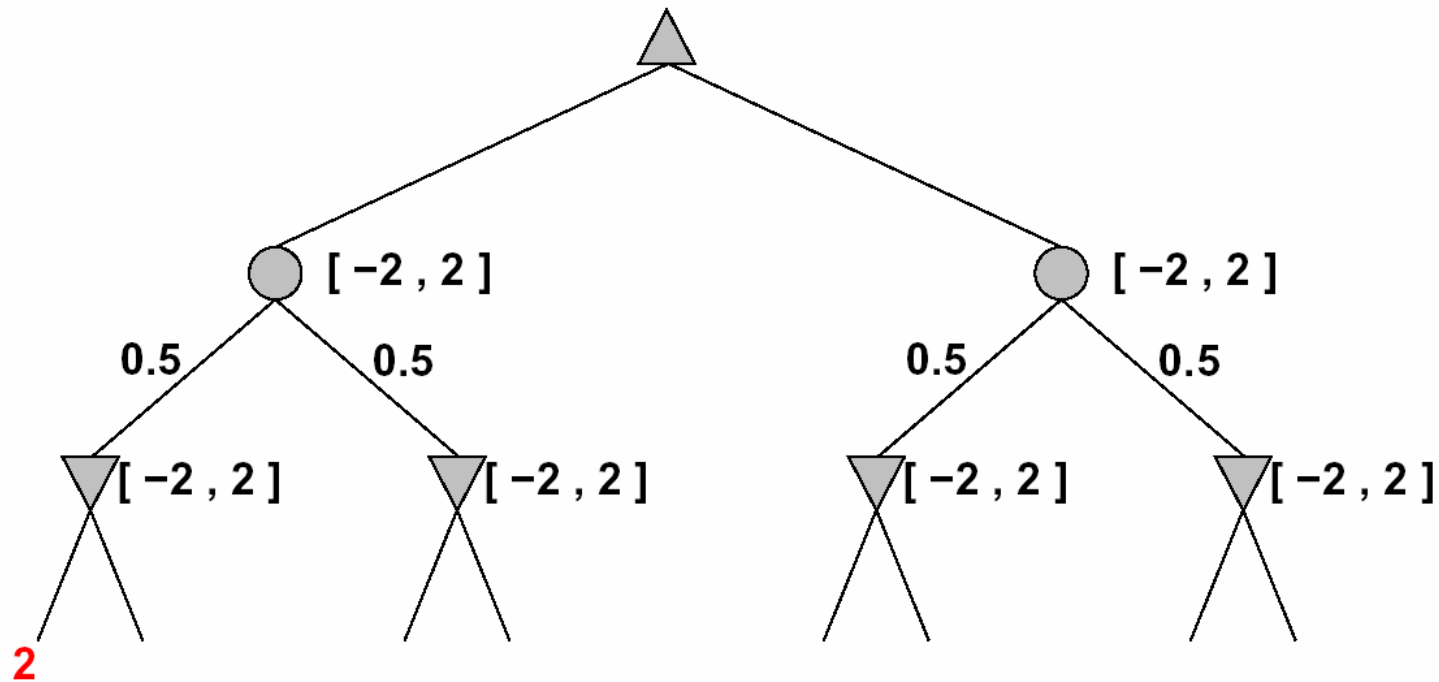

Pruning with Bounds (cont.)

- More pruning if we can bound the leaf values

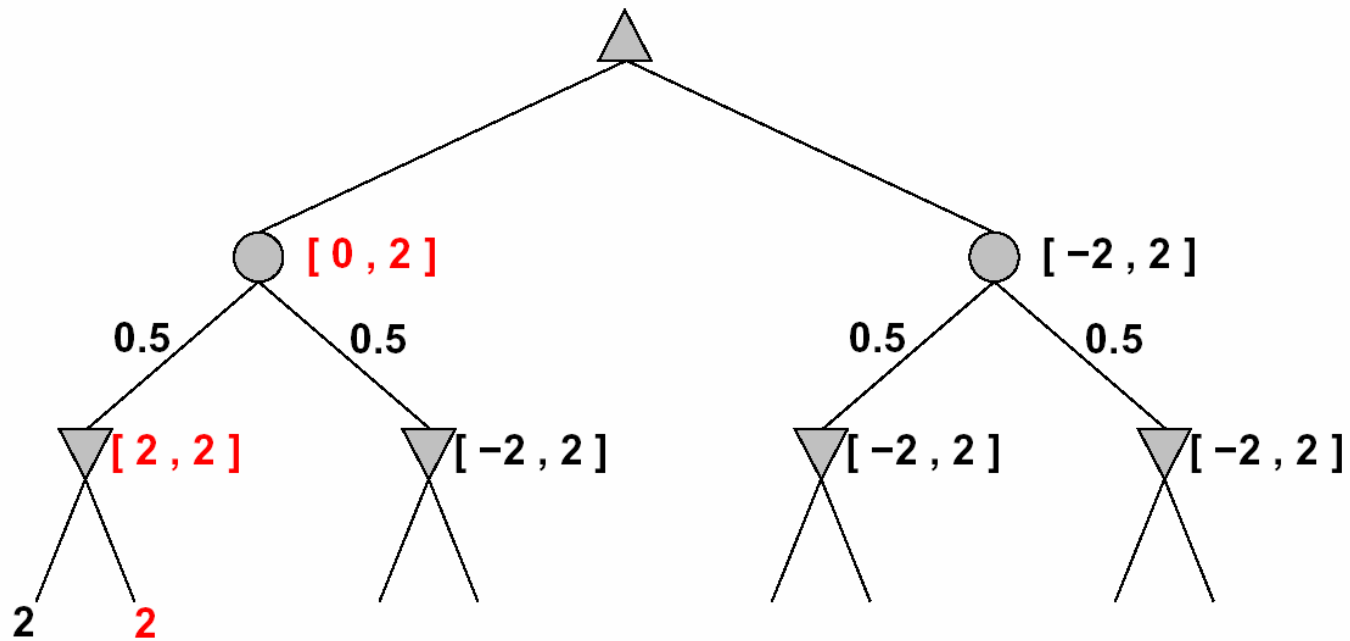

Pruning with Bounds (cont.)

- More pruning if we can bound the leaf values

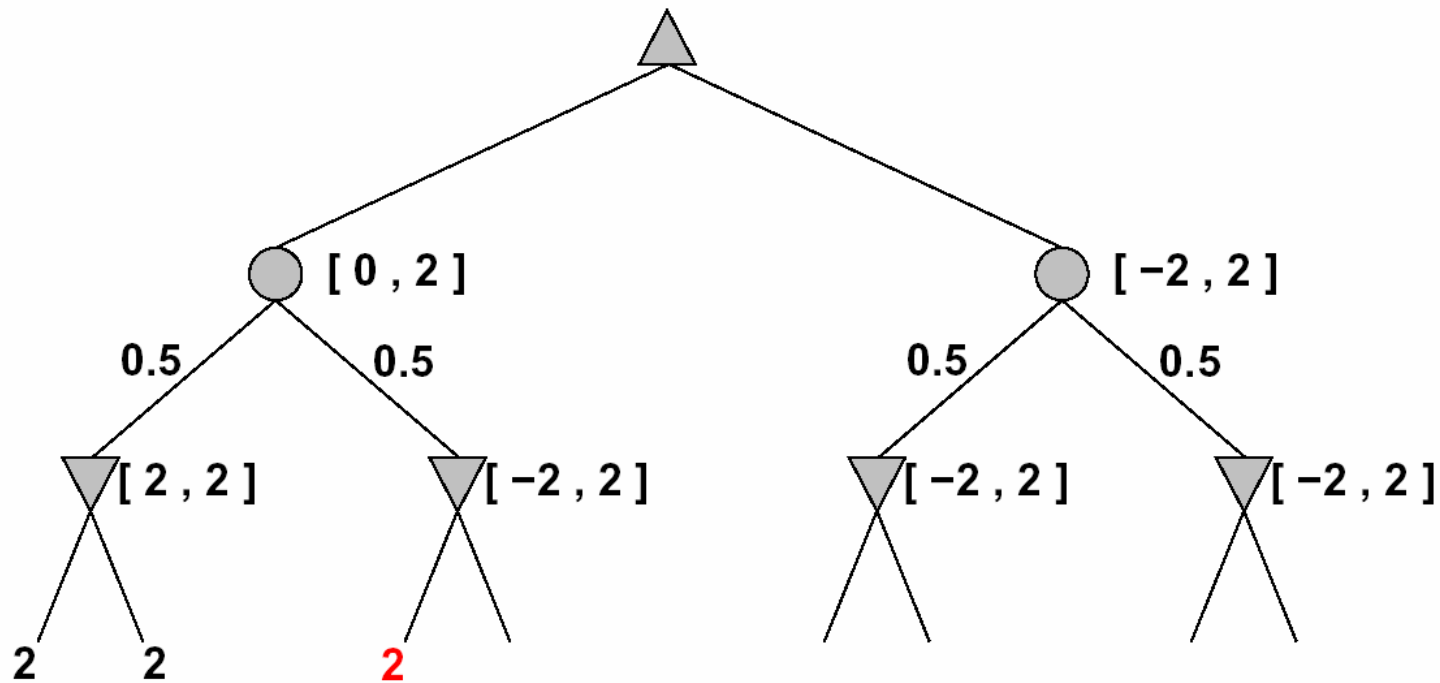

Pruning with Bounds (cont.)

- More pruning if we can bound the leaf values

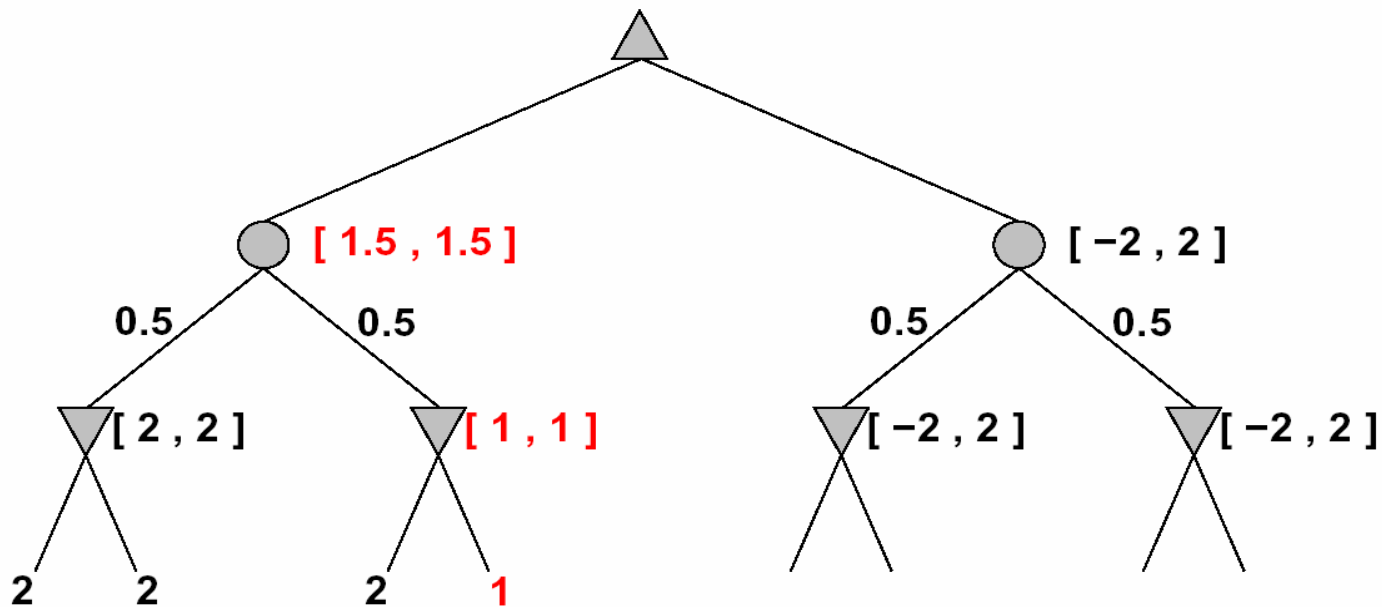

Pruning with Bounds (cont.)

- More pruning if we can bound the leaf values

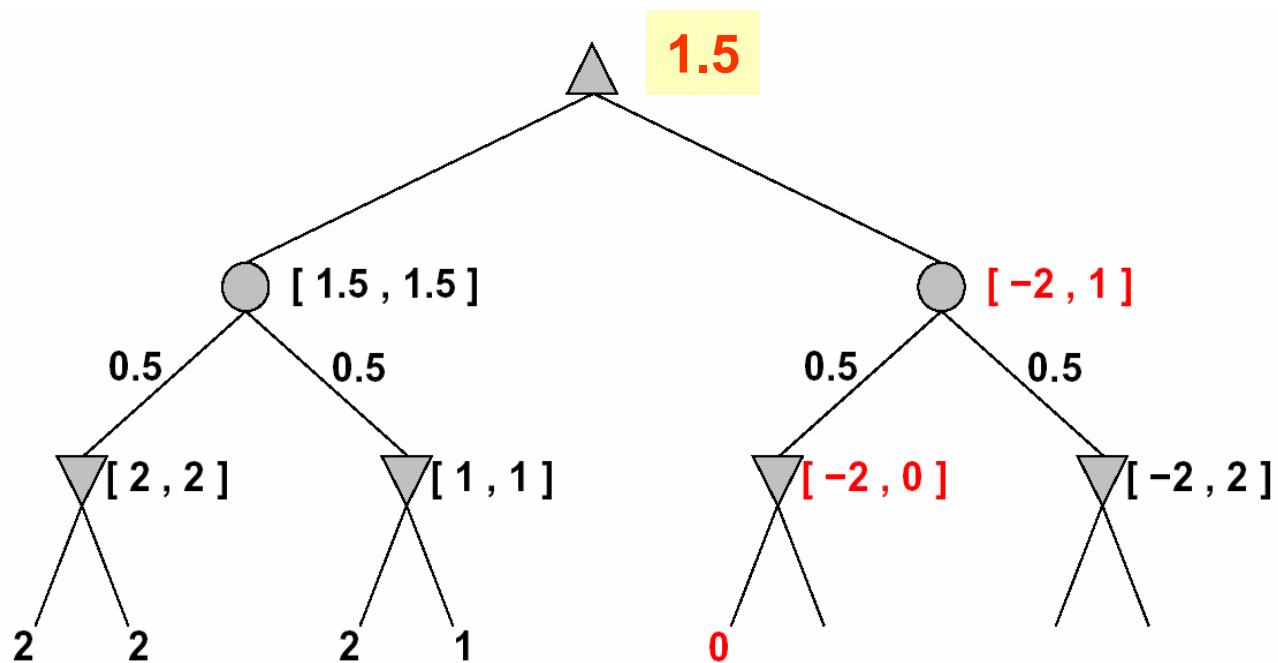

- Save 2/7 operations than the previously unconstrained approach

Nondeterministic Games in Practice

- For backgammon with two dice rolled
 - 20 legal moves in average (could be more than 4,000 for 1-1 roll)
 - Branching factor $b \approx 20$
 - 21 possible rolls
 - Number of distinct rolls $n=21$
 - E.g., if depth=4

$$20 \times (21 \times 20)^3 \approx 1.2 \times 10^9$$

possible chances

branching factor

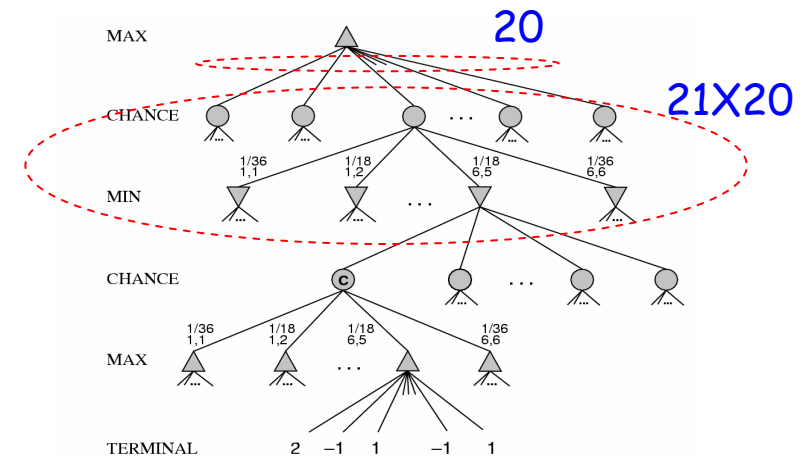

- $\alpha - \beta$ pruning is much less effective here

Digression: Exact Value Do Matter

- Behavior is preserved only by positive linear transformation of evaluation function *Eval*
 - Hence, *Eval* should be propositional to the expected payoff

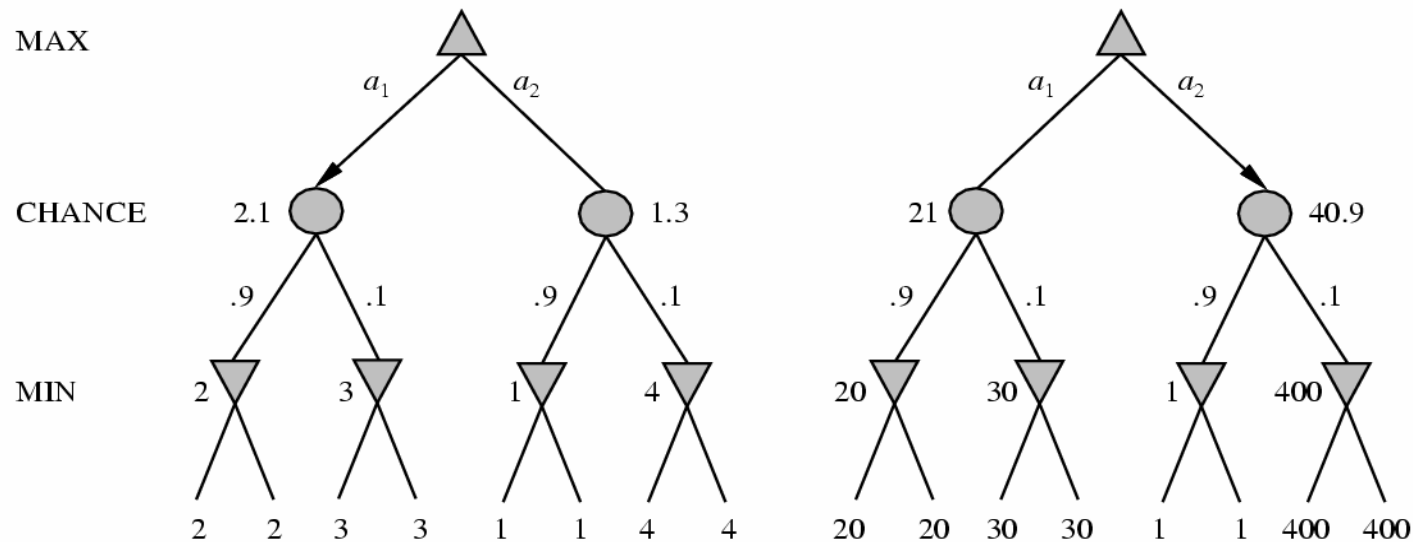

Games of Imperfect Information

- E.g., card game, where opponent's initial cards are unknown
 - Typically we can calculate a probability for each possible deal
 - Seems just **like having one big dice roll** at the beginning of the game
- Idea: compute the minimax value of each action in each deal, then choose the action with highest expected value over all deals
 - Special case: if an action is optimal for all deals, it's optimal
- GIB, current best bridge program, approximate this idea by
 - Generating **100 deals consistent with bidding information**
 - Picking the action that wins most tricks on average

Example

- Four-card bridge/whist/hearts hand, Max to play first

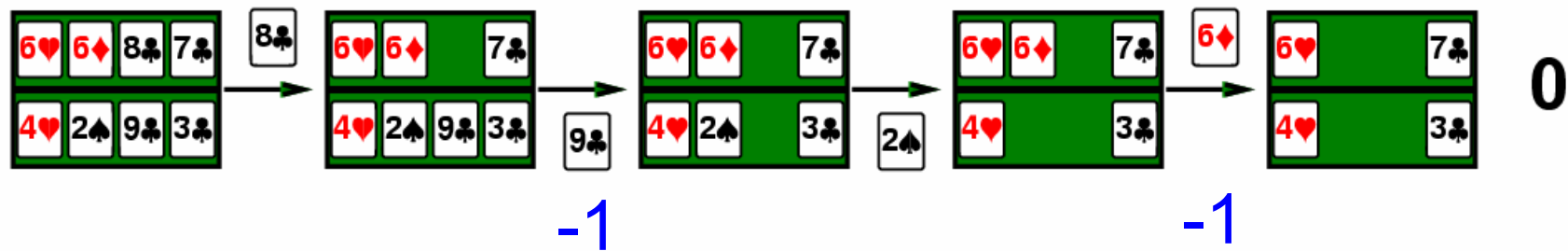

♣ club
♥ heart
♠ spade
♦ diamond

Example (cont.)

- Four-card bridge/whist/hearts hand, Max to play first

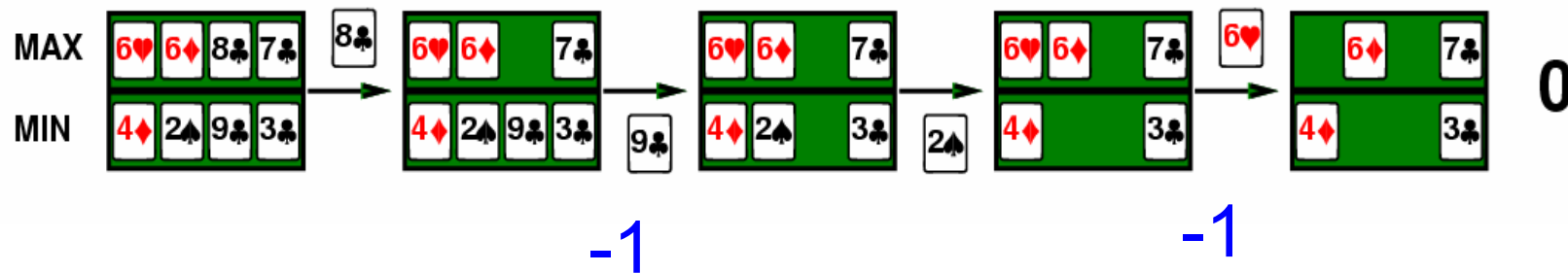

Example (cont.)

- Four-card bridge/whist/hearts hand, Max to play first

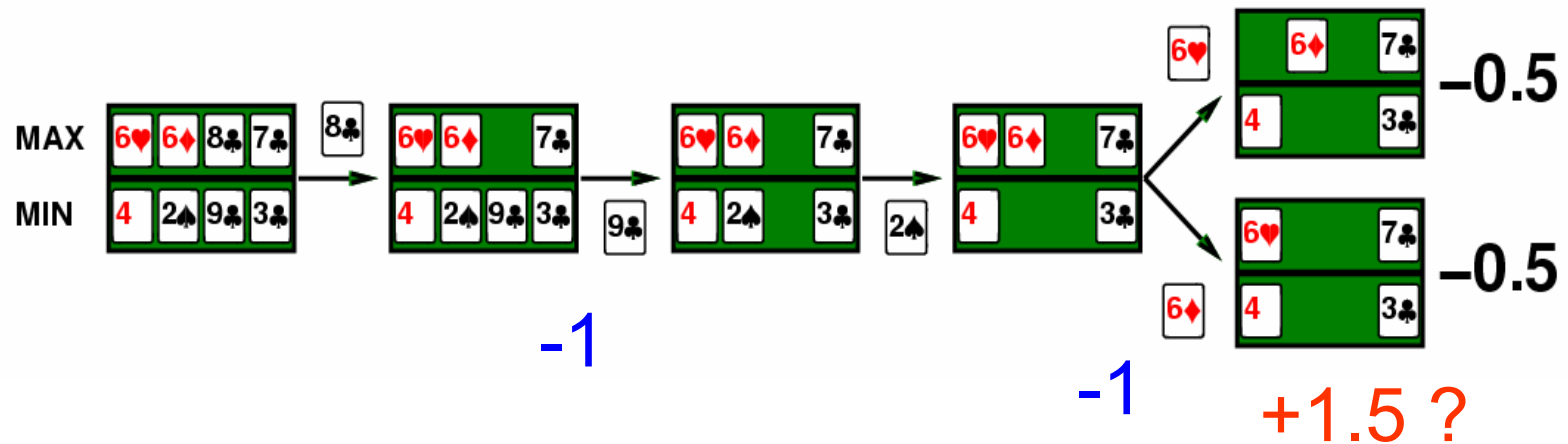

Example (cont.)

