

Continuous Random Variables: Derived Distributions



Berlin Chen

Department of Computer Science & Information Engineering
National Taiwan Normal University



Reference:

- D. P. Bertsekas, J. N. Tsitsiklis, *Introduction to Probability*, Section 3.6

Two-step approach to Calculating Derived PDF

- Calculate the PDF of a Function $Y = g(X)$ of a continuous random variable X
 1. Calculate the CDF F_Y of Y using the formula

$$F_Y(y) = \mathbf{P}(g(X) \leq y) = \int_{\{x|g(x) \leq y\}} f_X(x) dx$$

2. Differentiate to obtain the PDF (called the derived distribution) of Y

$$f_Y(y) = \frac{dF_Y(y)}{dy}$$

Illustrative Examples (1/2)

- **Example 3.20.** Let X be uniform on $[0, 1]$. Find the PDF of $Y = \sqrt{X}$. Note that Y takes values between 0 and 1.

$$F_Y(y) = \mathbf{P}(Y \leq y) = \mathbf{P}(\sqrt{X} \leq y) = \mathbf{P}(X \leq y^2) = y^2$$

$$\therefore f_Y(y) = \frac{dF_Y(y)}{dy} = 2y, \quad 0 \leq y \leq 1$$

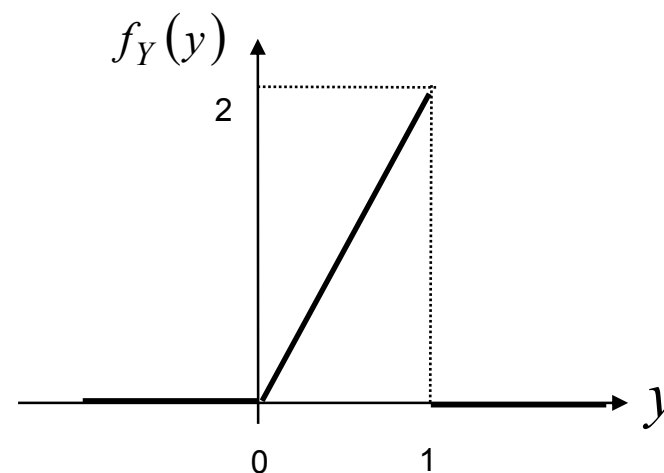
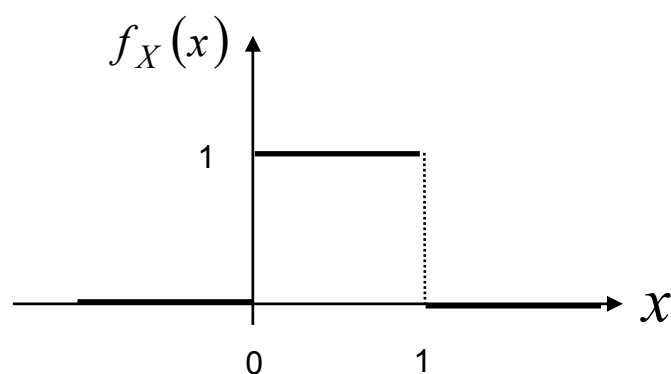

Illustrative Examples (2/2)

- **Example 3.22.** Let $Y = X^2$, where X is a random variable with known PDF $f_X(x)$. Find the PDF of Y represented in terms of $f_X(x)$.

For any $y \geq 0$, we have

$$\begin{aligned} F_Y(y) &= \mathbf{P}(Y \leq y) = \mathbf{P}(X^2 \leq y) \\ &= \mathbf{P}(-\sqrt{y} \leq X \leq \sqrt{y}) \\ &= F_X(\sqrt{y}) - F_X(-\sqrt{y}) \end{aligned}$$

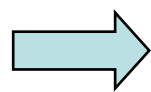

$$\begin{aligned} f_Y(y) &= \frac{dF_Y(y)}{dy} \\ &= \left[\frac{dF_X(\sqrt{y})}{d\sqrt{y}} \cdot \frac{d\sqrt{y}}{dy} \right] - \left[\frac{dF_X(-\sqrt{y})}{d(-\sqrt{y})} \cdot \frac{d(-\sqrt{y})}{dy} \right] \\ &= \frac{1}{2\sqrt{y}} f_X(\sqrt{y}) + \frac{1}{2\sqrt{y}} f_X(-\sqrt{y}) \\ &= \frac{1}{2\sqrt{y}} [f_X(\sqrt{y}) + f_X(-\sqrt{y})] \end{aligned}$$

The PDF of a Linear Function of a Random Variable

- Let X be a continuous random variable with PDF $f_X(x)$, and let

$$Y = aX + b,$$

for some scalar $a \neq 0$ and b . Then,

$$f_Y(y) = \frac{1}{|a|} f_X\left(\frac{y-b}{a}\right)$$

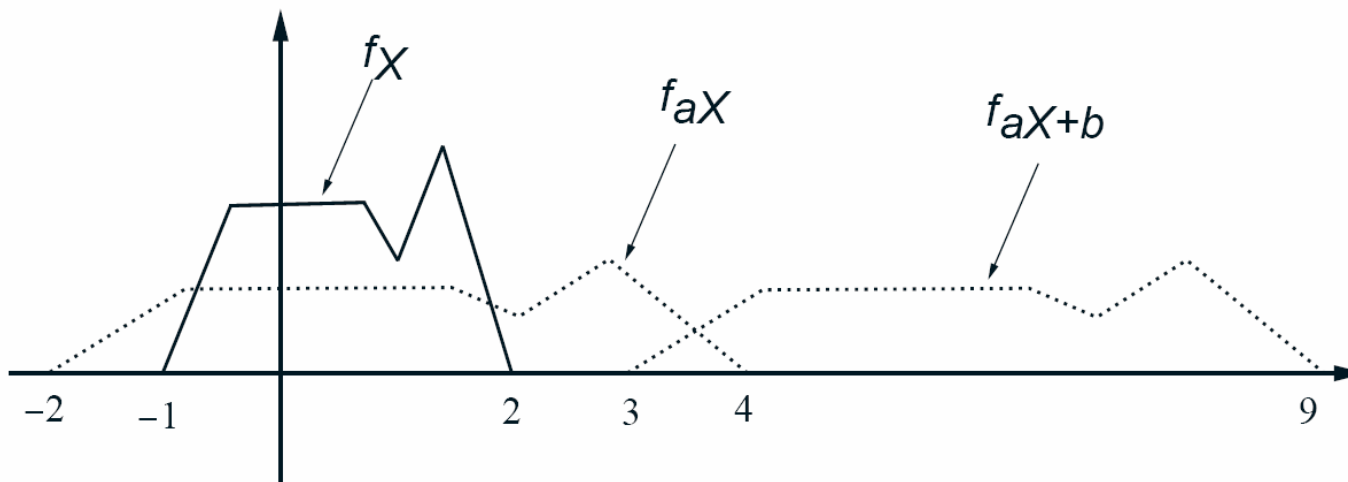

$a > 0, b > 0$

The PDF of a Linear Function of a Random Variable (1/2)

- Verification of the above formula

$$F_Y(y) = \mathbf{P}(Y \leq y) = \mathbf{P}(aX + b \leq y)$$

(i) For $a > 0$

$$F_Y(y) = \mathbf{P}\left(X \leq \frac{y-b}{a}\right) = F_X\left(\frac{y-b}{a}\right)$$
$$\Rightarrow f_Y(y) = \frac{dF_X\left(\frac{y-b}{a}\right)}{d\left(\frac{y-b}{a}\right)} \cdot \frac{d\left(\frac{y-b}{a}\right)}{dy} = \frac{1}{a} f_X\left(\frac{y-b}{a}\right)$$

(ii) For $a < 0$

$$F_Y(y) = \mathbf{P}\left(X \geq \frac{y-b}{a}\right) = 1 - F_X\left(\frac{y-b}{a}\right)$$
$$\Rightarrow f_Y(y) = -\frac{dF_X\left(\frac{y-b}{a}\right)}{d\left(\frac{y-b}{a}\right)} \cdot \frac{d\left(\frac{y-b}{a}\right)}{dy} = -\frac{1}{a} f_X\left(\frac{y-b}{a}\right)$$
$$\therefore f_Y(y) = \frac{1}{|a|} f_X\left(\frac{y-b}{a}\right)$$

Illustrative Examples (1/2)

- **Example 3.23. A linear function of an exponential random variable.**

- Suppose that X is an exponential random variable with PDF

$$f_X(x) = \begin{cases} \lambda e^{-\lambda x}, & \text{if } x \geq 0, \\ 0, & \text{otherwise.} \end{cases}$$

- where λ is a positive parameter. Let $Y = aX + b$. Then,

$$f_Y(y) = \begin{cases} \frac{1}{|a|} \lambda e^{-\lambda(y-b)/a}, & \text{if } (y-b)/a \geq 0, \\ 0, & \text{otherwise.} \end{cases}$$

Illustrative Examples (2/2)

- **Example 3.24. A linear function of a normal random variable is normal.**

- Suppose that X is a normal random variable with mean μ and variance σ^2 ,

$$f_X(x) = \frac{1}{\sqrt{2\pi}\sigma} e^{-\frac{(x-\mu)^2}{2\sigma^2}}, \quad -\infty \leq x \leq \infty$$

- And let $Y = aX + b$, where a and b are some scalars. We have

$$f_Y(y) = \frac{1}{|a|} f_X\left(\frac{y-b}{a}\right)$$

$$= \frac{1}{|a|} \frac{1}{\sqrt{2\pi}\sigma} e^{-\frac{\left(\frac{y-b}{a} - \mu\right)^2}{2\sigma^2}} \quad \therefore Y \text{ is also a normal random variable with mean } a\mu + b \text{ and variance } a^2\sigma^2$$

$$= \frac{1}{\sqrt{2\pi}|a|\sigma} e^{-\frac{(y-(b+a\mu))^2}{2a^2\sigma^2}}, \quad -\infty \leq y \leq \infty$$

Monotonic Functions of a Random Variable (1/4)

- Let X be a continuous random variable and have values in a certain interval I ($f_X(x) = 0$ for $x \notin I$). While random variable $Y = g(X)$ and we assume that g is **strictly monotonic** over the interval I . That is, either
 - $g(x) < g(x')$ for all $x, x' \in I$, satisfying $x < x'$ (**monotonically increasing case**), or
 - $g(x) > g(x')$ for all $x, x' \in I$, satisfying $x < x'$ (**monotonically decreasing case**)

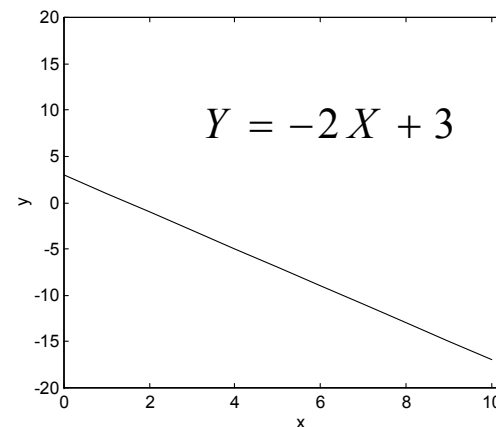
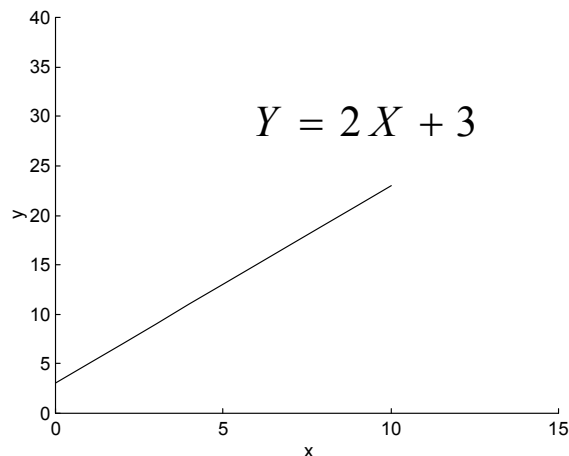

Monotonic Functions of a Random Variable (2/4)

- Suppose that g is monotonic and that for some function h and all x in the range I of X we have

$$y = g(x) \quad \text{if and only if} \quad x = h(y)$$

– For example,

$$y = g(x) = ax + b \quad \Rightarrow \quad x = h(y) = \frac{y - b}{a}$$

$$y = g(x) = e^{ax} \quad \Rightarrow \quad x = h(y) = \frac{\ln y}{a}$$

$$y = g(x) = -ax + b \quad \Rightarrow \quad x = h(y) = -\frac{y - b}{a}$$

Monotonic Functions of a Random Variable (3/4)

- Assume that h has first derivative $\frac{dh(y)}{dy}$. Then the PDF of Y in the region where $f_Y(y) > 0$ is given by

$$f_Y(y) = f_X(h(y)) \left| \frac{dh(y)}{dy} \right|$$

- For the monotonically increasing case

$$F_Y(y) = \mathbf{P}(g(X) \leq y) = \mathbf{P}(X \leq h(y)) = F_X(h(y))$$

$$\begin{aligned} \Rightarrow f_Y(y) &= \frac{dF_Y(y)}{dy} \\ &= \frac{dF_X(h(y))}{dy} = \frac{dF_X(h(y))}{dh(y)} \cdot \frac{dh(y)}{dy} \\ &= f_X(h(y)) \cdot \frac{dh(y)}{dy} \quad \frac{dh(y)}{dy} > 0 \end{aligned}$$

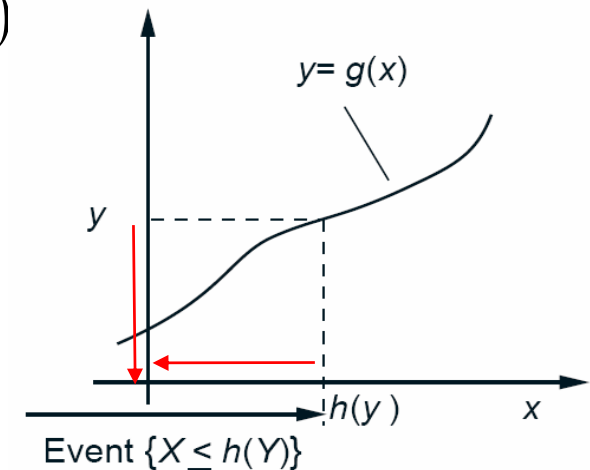

Monotonic Functions of a Random Variable (4/4)

- For the monotonically decreasing case

$$F_Y(y) = \mathbf{P}(g(X) \leq y) = \mathbf{P}(X \geq h(y)) = 1 - F_X(h(y))$$

$$\Rightarrow f_Y(y) = \frac{dF_Y(y)}{dy}$$

$$= -\frac{dF_X(h(y))}{dy} = -\frac{dF_X(h(y))}{dh(y)} \cdot \frac{dh(y)}{dy}$$

$$= -f_X(h(y)) \cdot \frac{dh(y)}{dy}$$

$$\frac{dh(y)}{dy} < 0$$

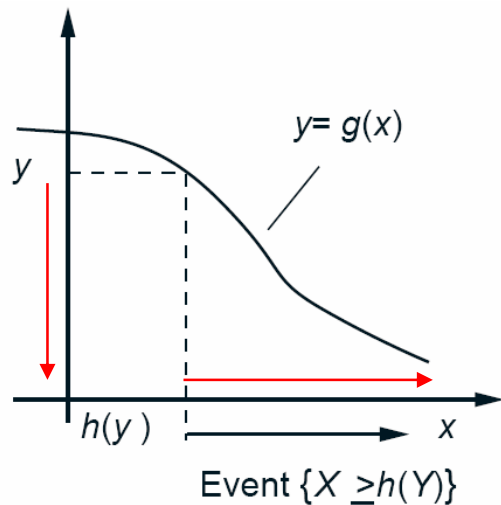

Illustrative Examples (1/5)

- **Example 3.25.** Let $Y = g(X) = X^2$, where X is a continuous uniform random variable in the interval $(0, 1]$.
 - What is the PDF of y ?
 - Within this interval, g is strictly monotonic, and its inverse is $h(y) = \sqrt{y}$

We have

$$f_X(x) = 1 \quad \text{for all } 0 < x \leq 1$$

and $g(X)$ being strictly increasing

\Rightarrow

$$f_X(\sqrt{y}) = 1, \quad \text{for all } 0 < y \leq 1$$

$$\therefore f_Y(y) = \frac{dh(y)}{dy} f_X(\sqrt{y}) = \begin{cases} \frac{1}{2\sqrt{y}}, & \text{if } y \in (0, 1] \\ 0, & \text{otherwise} \end{cases}$$

Illustrative Examples (2/5)

- **Example 3.26.** Let X and Y be independent random variables that are uniformly distributed on the interval $[0, 1]$, respectively. What is the PDF of the random variable $Z = \max \{X, Y\}$

$$\begin{aligned} F_Z(z) &= \mathbf{P}(\max \{X, Y\} \leq z) \\ &= \mathbf{P}(X \leq z, Y \leq z) \\ &= \mathbf{P}(Y \leq z)\mathbf{P}(Y \leq z) \\ &= z^2 \end{aligned}$$

$$\therefore f_Z(z) = \begin{cases} 2z, & \text{if } 0 \leq z \leq 1 \\ 0, & \text{otherwise} \end{cases}$$

Illustrative Examples (3/5)

- Example 3.27.** Let X and Y be independent random variables that are uniformly distributed on the interval $[0, 1]$. What is the PDF of the random variable $Z = Y / X$

$\because X, Y$ are independent

$$\because f_{X,Y}(x,y) = f_X(x)f_Y(y) = 1,$$

for all $x, y, 0 \leq x, y \leq 1$

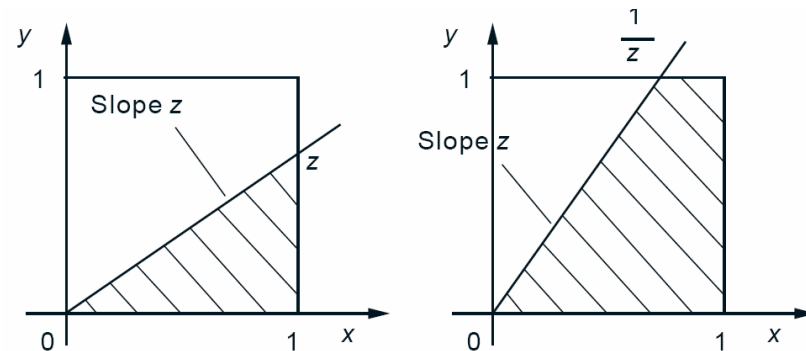

$$F_Z(z) = \mathbf{P}(Y / X \leq z)$$

$$= \begin{cases} z/2, & \text{if } 0 \leq z \leq 1 \\ 1 - (1/2z), & \text{if } z > 1 \\ 0, & \text{otherwise} \end{cases}$$

$$\Rightarrow f_Z(z) = \begin{cases} 1/2, & \text{if } 0 \leq z \leq 1 \\ 1/(2z^2), & \text{if } z > 1 \\ 0, & \text{otherwise} \end{cases}$$

Illustrative Examples (4/5)

- Extra Example.** Let X and Y be independent random variables that are uniformly distributed on the interval $[0, 1]$, respectively. What is the PDF of the random variable $Z = XY$

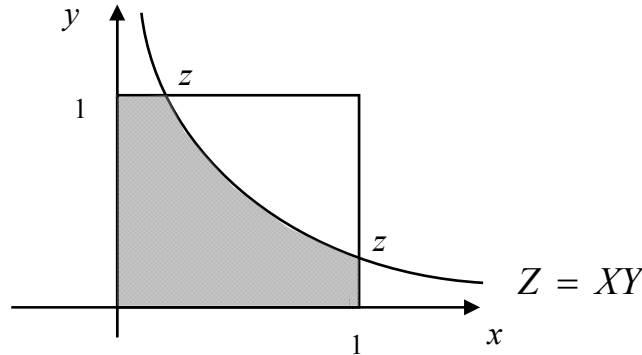

$$\Rightarrow \text{for } 0 < z \leq 1, \\ f_Z(z) = \ln z$$

for $0 < z \leq 1$

$$F_Z(z) = P(XY \leq z)$$

$$= \int_0^z \int_0^1 f_{X,Y}(x, y) dy dx + \int_z^1 \int_0^{\frac{z}{x}} f_{X,Y}(x, y) dy dx$$

$$= \int_0^z \int_0^1 1 dy dz + \int_z^1 \frac{z}{x} dx$$

$$= z + z \ln x \Big|_z^1$$

$$= z - z \ln z$$

For example,

$$F_Z(1/8) = P(XY \leq 1/8) \\ = \frac{1}{8} - \frac{1}{8} \ln \frac{1}{8} = \frac{1}{8} + \frac{3}{8} \ln 2$$

Illustrative Examples (5/5)

- Example 3.27.** Let X and Y be independent random variables that are exponential distributed with parameter λ . What is the PDF of the random variable $Z = X - Y$

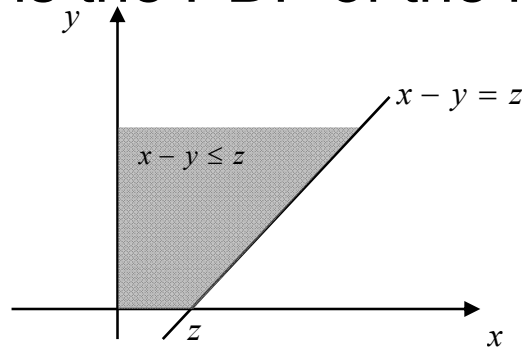

for $z \geq 0$

$$F_Z(z) = P(X - Y \leq z)$$

$$= \int_0^\infty \int_0^{y+z} f_{X,Y}(x, y) dx dy$$

$$= \int_0^\infty \int_0^{y+z} \lambda e^{-\lambda y} \lambda e^{-\lambda x} dx dy$$

$$= \int_0^\infty \lambda e^{-\lambda y} \left(\int_0^{y+z} \lambda e^{-\lambda x} dx \right) dy$$

$$= \int_0^\infty \lambda e^{-\lambda y} \left(-e^{-\lambda x} \Big|_0^{y+z} \right) dy$$

$$= \int_0^\infty \lambda e^{-\lambda y} dy - \int_0^\infty e^{-\lambda z} \lambda e^{-2\lambda y} dy$$

$$= 1 - \frac{1}{2} e^{-\lambda z}$$

\Rightarrow for $z \geq 0$,

$$f_Z(z) = \frac{1}{2} e^{-\lambda z}$$

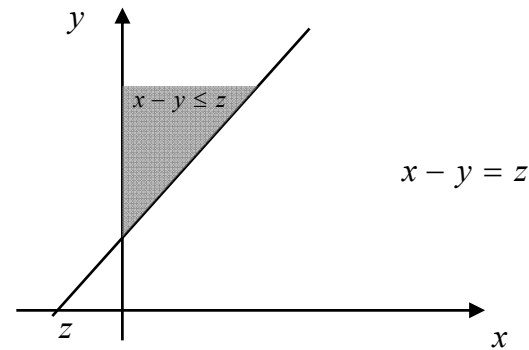

for $z \leq 0$

$$F_Z(z) = P(X - Y \leq z)$$

$$= \int_{-z}^\infty \int_0^{y+z} f_{X,Y}(x, y) dx dy$$

$$= \int_{-z}^\infty \int_0^{y+z} \lambda e^{-\lambda y} \lambda e^{-\lambda x} dx dy$$

$$= \int_{-z}^\infty \lambda e^{-\lambda y} \left(\int_0^{y+z} \lambda e^{-\lambda x} dx \right) dy$$

$$= \int_{-z}^\infty \lambda e^{-\lambda y} \left(-e^{-\lambda x} \Big|_0^{y+z} \right) dy$$

$$= \int_{-z}^\infty \lambda e^{-\lambda y} dy - \frac{1}{2} e^{-\lambda z} \int_{-z}^\infty 2 \lambda e^{-2\lambda y} dy$$

$$= e^{\lambda z} - \frac{1}{2} e^{-\lambda z} e^{2\lambda z}$$

$$= \frac{1}{2} e^{\lambda z}$$

\Rightarrow for $z \leq 0$,

$$f_Z(z) = \frac{1}{2} e^{\lambda z}$$

Recitation

- SECTION 3.6 Derived Functions
 - Problems 30, 31, 36, 38, 39