

Discriminative Feature Extraction and Dimension Reduction

- *PCA & LDA*

Berlin Chen, 2004

Introduction

- Goal: discover significant patterns or features from the input data
 - Salient feature selection or dimensionality reduction

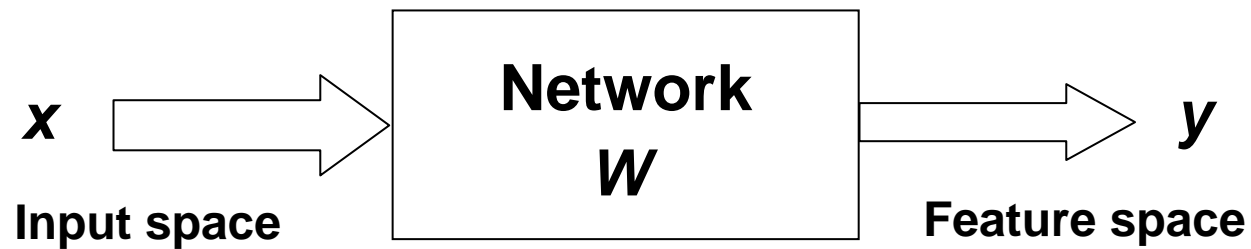

- Compute an input-output mapping based on some desirable properties

Introduction

- Principal Component Analysis (PCA)
- Linear Discriminant Analysis (LDA)

Introduction

- Formulation for discriminative feature extraction
 - Model-free (nonparametric)
 - Without prior information: e.g., PCA
 - With prior information: e.g., LDA
 - Model-dependent (parametric)
 - E.g., EM (Expectation-Maximization), MCE (Minimum Classification Error) Training

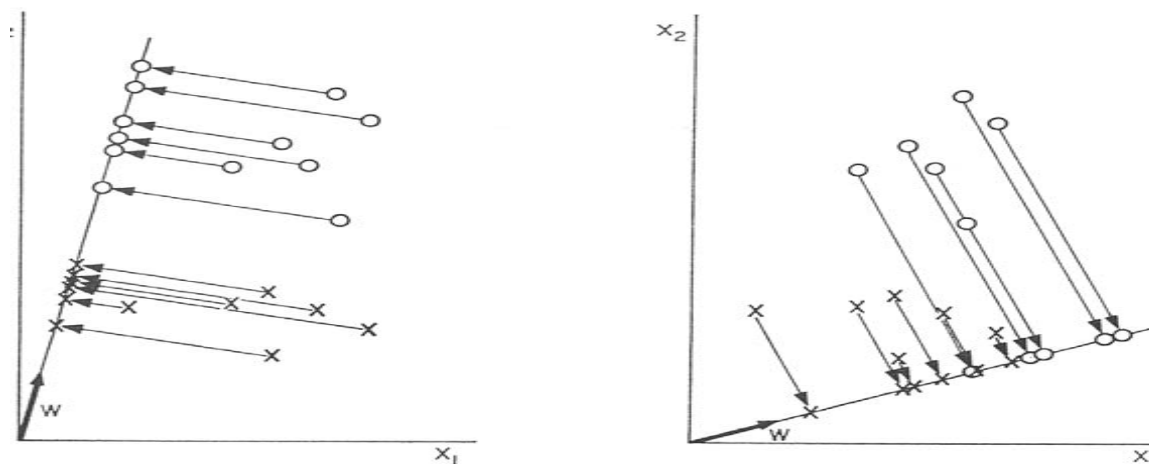

FIGURE 4.6. Projection of samples onto a line.

Principle Component Analysis (PCA)

Pearson, 1901

- Known as Karhunen-Loève Transform (1947, 1963)
 - Or Hotelling Transform (1933)
- A standard technique commonly used for data reduction in statistical pattern recognition and signal processing
- A transform by which the data set can be represented by reduced number of effective features and still retain the most intrinsic information content
 - A small set of features to be found to represent the data samples accurately
- Also called “Subspace Decomposition”

Principle Component Analysis

The patterns show a significant difference from each other in one of the transformed axes

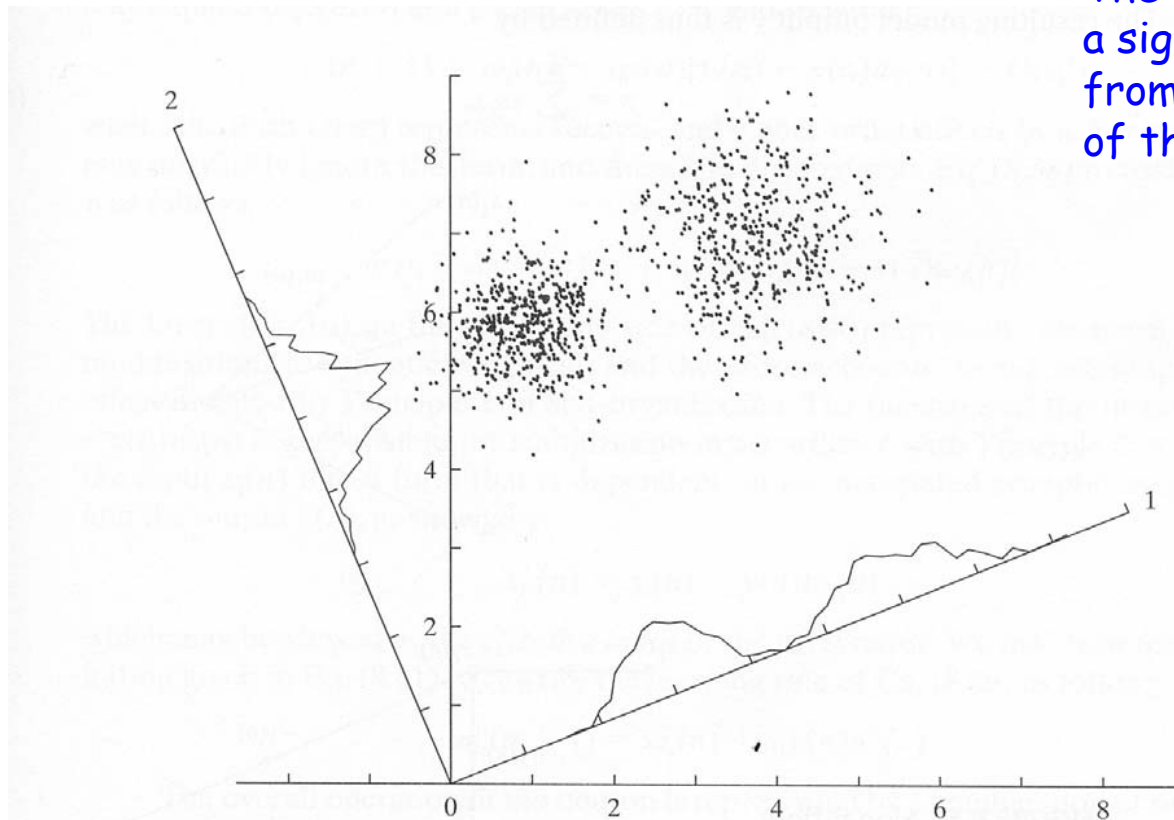

FIGURE 8.4 A cloud of data points is shown in two dimensions, and the density plots formed by projecting this cloud onto each of two axes, 1 and 2, are indicated. The projection onto axis 1 has maximum variance, and clearly shows the bimodal, or clustered character of the data.

Principle Component Analysis

- Suppose \mathbf{x} is an n -dimensional zero mean random vector, $E_x \{ \mathbf{x} \} = \mathbf{0}$
 - If \mathbf{x} is not zero mean, we can subtract the mean before processing the following analysis
 - \mathbf{x} can be represented without error by the summation of n linearly independent vectors

$$\mathbf{x} = \sum_{i=1}^n \underbrace{y_i}_{\text{The } i\text{-th component in the feature (mapped) space}} \boldsymbol{\varphi}_i = \boldsymbol{\Phi} \mathbf{y} \quad \text{where} \quad \mathbf{y} = [y_1 \quad \cdot \quad y_i \quad \cdot \quad y_n]^T$$
$$\boldsymbol{\Phi} = [\underbrace{\boldsymbol{\varphi}_1 \quad \cdot \quad \boldsymbol{\varphi}_i \quad \cdot \quad \boldsymbol{\varphi}_n}_{\text{The basis vectors}}]$$

Principle Component Analysis

- Further assume the column (basis) vectors of the matrix Φ form an orthonormal set

$$\varphi_i^T \varphi_j = \begin{cases} 1 & \text{if } i = j \\ 0 & \text{if } i \neq j \end{cases}$$

- Such that y_i is equal to the projection of \mathbf{x} on φ_i

$$\forall_i \quad y_i = \mathbf{x}^T \varphi_i = \varphi_i^T \mathbf{x}$$

- y_i also has the following properties

- Its mean is zero, too

$$E\{y_i\} = E\{\varphi_i^T \mathbf{x}\} = \varphi_i^T E\{\mathbf{x}\} = \varphi_i^T \mathbf{0} = 0$$

- Its variance is

$$\sigma_i^2 = E\{y_i^2\} = E\{\varphi_i^T \mathbf{x} \mathbf{x}^T \varphi_i\} = \varphi_i^T E\{\mathbf{x} \mathbf{x}^T\} \varphi_i$$

$$\mathbf{R} = E\{\mathbf{x} \mathbf{x}^T\} = \frac{1}{N} \sum_i \mathbf{x}_i \mathbf{x}_i^T$$

$$= \varphi_i^T \mathbf{R} \varphi_i \quad [\mathbf{R} \text{ is the (auto-)correlation matrix of } \mathbf{x}]$$

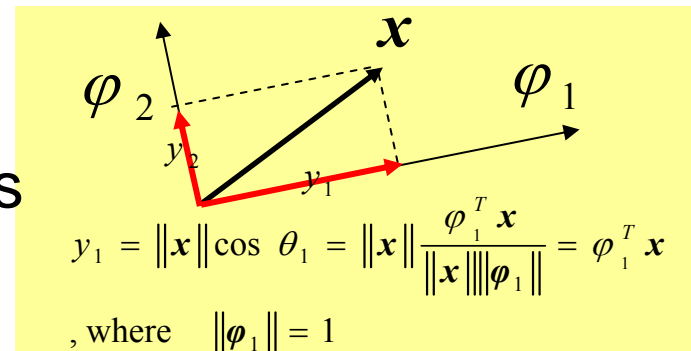

Principle Component Analysis

– Further assume the column (basis) vectors of the matrix Φ form an orthonormal set

- y_i also has the following properties

– Its mean is zero, too

$$E\{y_i\} = E\{\varphi_i^T \mathbf{x}\} = \varphi_i^T E\{\mathbf{x}\} = \varphi_i^T \mathbf{0} = 0$$

– Its variance is

$$\begin{aligned}\sigma_i^2 &= E\{y_i^2\} = E\{\varphi_i^T \mathbf{x} \mathbf{x}^T \varphi_i\} = \varphi_i^T E\{\mathbf{x} \mathbf{x}^T\} \varphi_i \\ &= \varphi_i^T \mathbf{R} \varphi_i \quad [\mathbf{R} \text{ is the (auto-)correlation matrix of } \mathbf{x}]\end{aligned}$$

$$\mathbf{R} = E\{\mathbf{x} \mathbf{x}^T\} = \frac{1}{N} \sum_i \mathbf{x}_i \mathbf{x}_i^T$$

- The correlation between two projections y_i and y_j is

$$\begin{aligned}E\{y_i y_j\} &= E\{(\varphi_i^T \mathbf{x})(\varphi_j^T \mathbf{x})^T\} = E\{\varphi_i^T \mathbf{x} \mathbf{x}^T \varphi_j\} \\ &= \varphi_i^T E\{\mathbf{x} \mathbf{x}^T\} \varphi_j = \varphi_i^T \mathbf{R} \varphi_j\end{aligned}$$

Principle Component Analysis

- Minimum Mean-Squared Error Criterion
 - We want to choose only m of $\boldsymbol{\varphi}_i$'s that we still can approximate \mathbf{x} well in **mean-squared error criterion**

$$\mathbf{x} = \sum_{i=1}^n y_i \boldsymbol{\varphi}_i = \sum_{i=1}^m y_i \boldsymbol{\varphi}_i + \sum_{j=m+1}^n y_j \boldsymbol{\varphi}_j$$

$$\hat{\mathbf{x}}(m) = \sum_{i=1}^m y_i \boldsymbol{\varphi}_i$$

$$\bar{\varepsilon}(m) = E \left\{ \|\hat{\mathbf{x}}(m) - \mathbf{x}\|^2 \right\} = E \left\{ \left(\sum_{j=m+1}^n y_j \boldsymbol{\varphi}_j^T \right) \left(\sum_{k=m+1}^n y_k \boldsymbol{\varphi}_k \right) \right\}$$

$$= E \left\{ \sum_{j=m+1}^n \sum_{k=m+1}^n y_j y_k \boldsymbol{\varphi}_j^T \boldsymbol{\varphi}_k \right\}$$

$$= \sum_{j=m+1}^n E \left\{ y_j^2 \right\}$$

$$= \sum_{j=m+1}^n \sigma_j^2 = \sum_{j=m+1}^n \boldsymbol{\varphi}_j^T \mathbf{R} \boldsymbol{\varphi}_j$$

$$E \{ y_j \} = 0$$

$$\sigma_j^2 = E \{ y_j^2 \} - (E \{ y_j \})^2$$

$$= E \{ y_j^2 \}$$

$$\because \boldsymbol{\varphi}_j^T \boldsymbol{\varphi}_k = \begin{cases} 1 & \text{if } j = k \\ 0 & \text{if } j \neq k \end{cases}$$

We should discard the bases where the projections have lower variances

Principle Component Analysis

- Minimum Mean-Squared Error Criterion

- If the orthonormal (basis) set $\boldsymbol{\varphi}_i$'s is selected to be the eigenvectors of the correlation matrix \mathbf{R} , associated with eigenvalues λ_i 's

- They will have the property that:

$$\mathbf{R} \boldsymbol{\varphi}_j = \lambda_j \boldsymbol{\varphi}_j$$

\mathbf{R} is real and symmetric, therefore its eigenvectors form an orthonormal set

- Such that the mean-squared error mentioned above will be

$$\begin{aligned} \bar{\varepsilon}(m) &= \sum_{j=m+1}^n \sigma_j^2 \\ &= \sum_{j=m+1}^n \boldsymbol{\varphi}_j^T \mathbf{R} \boldsymbol{\varphi}_j = \sum_{j=m+1}^n \boldsymbol{\varphi}_j^T \lambda_j \boldsymbol{\varphi}_j = \sum_{j=m+1}^n \lambda_j \end{aligned}$$

Principle Component Analysis

- Minimum Mean-Squared Error Criterion
 - If the eigenvectors are retained associated with the m largest eigenvalues, the mean-squared error will be

$$\bar{\varepsilon}_{\text{eigen}}(m) = \sum_{j=m+1}^n \lambda_j \quad (\text{where } \lambda_1 \geq \dots \geq \lambda_m \geq \dots \geq \lambda_n)$$

- Any two projections y_i and y_j will be mutually uncorrelated

$$\begin{aligned} E \{y_i y_j\} &= E \left\{ (\boldsymbol{\varphi}_i^T \mathbf{x}) (\boldsymbol{\varphi}_j^T \mathbf{x})^T \right\} = E \left\{ \boldsymbol{\varphi}_i^T \mathbf{x} \mathbf{x}^T \boldsymbol{\varphi}_j \right\} \\ &= \boldsymbol{\varphi}_i^T E \left\{ \mathbf{x} \mathbf{x}^T \right\} \boldsymbol{\varphi}_j = \boldsymbol{\varphi}_i^T \mathbf{R} \boldsymbol{\varphi}_j = \lambda_j \boldsymbol{\varphi}_i^T \boldsymbol{\varphi}_j = 0 \end{aligned}$$

- Good news for most statistical modeling
 - Gaussians and diagonal matrices

Principle Component Analysis

- An two-dimensional example of Principle Component Analysis

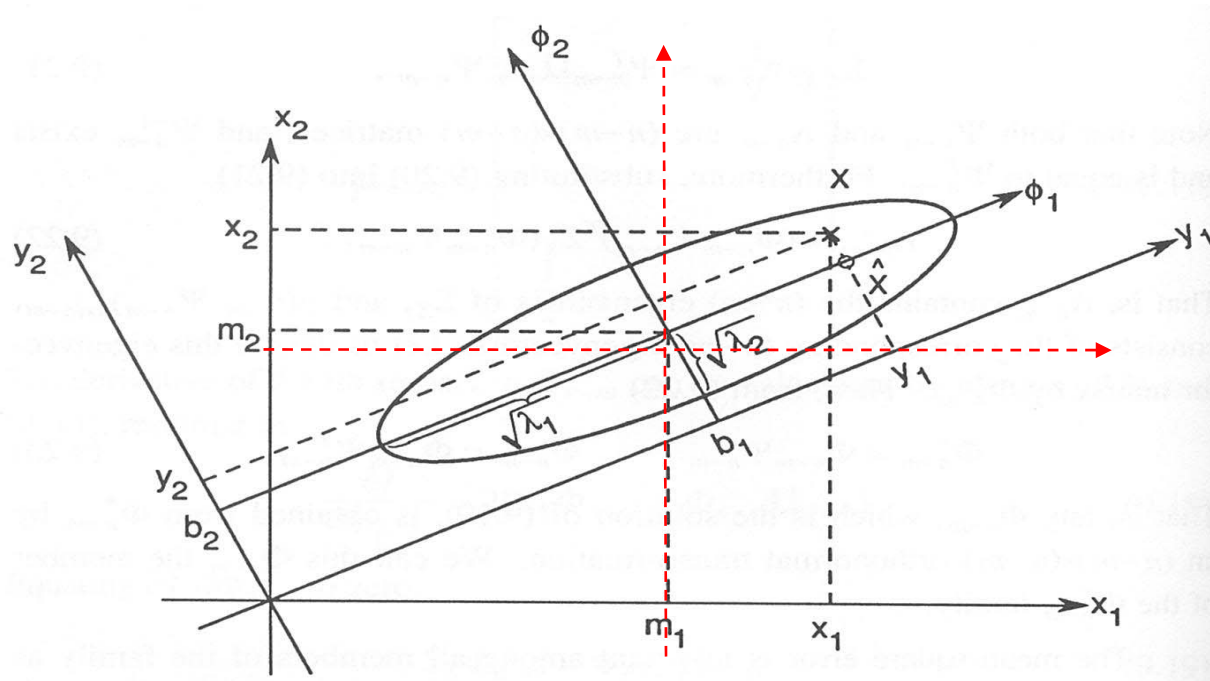

Principle Component Analysis

- Minimum Mean-Squared Error Criterion
 - It can be proved that $\bar{\varepsilon}_{eigen}(m)$ is the optimal solution under the mean-squared error criterion

To be minimized
constraints

Define: $J = \sum_{j=m+1}^n \boldsymbol{\varphi}_j^T \mathbf{R} \boldsymbol{\varphi}_j - \sum_{j=m+1}^n \sum_{k=m+1}^n \mu_{jk} (\boldsymbol{\varphi}_j^T \boldsymbol{\varphi}_k - \delta_{jk})$

$\frac{\partial \boldsymbol{\varphi}^T \mathbf{R} \boldsymbol{\varphi}}{\partial \boldsymbol{\varphi}} = 2 \mathbf{R} \boldsymbol{\varphi}$

Take derivation

$$\Rightarrow \forall_{m+1 \leq j \leq n} \frac{\partial J}{\partial \boldsymbol{\varphi}_j} = 2 \mathbf{R} \boldsymbol{\varphi}_j - 2 \sum_{k=m+1}^n \mu_{jk} \boldsymbol{\varphi}_k = 0 \quad \left(\text{where } \boldsymbol{\mu}_j^T = [\mu_{j, m+1} \dots \mu_{j, n}] \right)$$

$$\Rightarrow \forall_{m+1 \leq j \leq n} \mathbf{R} \boldsymbol{\varphi}_j = \boldsymbol{\Phi}_{n-m} \boldsymbol{\mu}_j \quad \left(\text{where } \boldsymbol{\Phi}_{n-m} = [\boldsymbol{\varphi}_{m+1} \dots \boldsymbol{\varphi}_n] \right)$$

$$\Rightarrow \mathbf{R} [\boldsymbol{\varphi}_{m+1} \dots \boldsymbol{\varphi}_n] = \boldsymbol{\Phi}_{n-m} [\boldsymbol{\mu}_{m+1} \dots \boldsymbol{\mu}_n]$$

$$\Rightarrow \mathbf{R} \boldsymbol{\Phi}_{n-m} = \boldsymbol{\Phi}_{n-m} \mathbf{U}_{n-m} \quad \left(\text{where } \mathbf{U}_{n-m} = [\boldsymbol{\mu}_{m+1} \dots \boldsymbol{\mu}_n] \right)$$

Have a particular solution if \mathbf{U}_{n-m} is a diagonal matrix and its diagonal elements is the eigenvalues $\lambda_{m+1} \dots \lambda_n$ of \mathbf{R} and $\boldsymbol{\varphi}_{m+1} \dots \boldsymbol{\varphi}_n$ is their corresponding eigenvectors

Principle Component Analysis

- Given an input vector \mathbf{x} with dimensional m
 - Try to construct a linear transform Φ' (Φ' is an $n \times m$ matrix $m < n$) such that the truncation result, $\Phi'^T \mathbf{x}$, is optimal in mean-squared error criterion

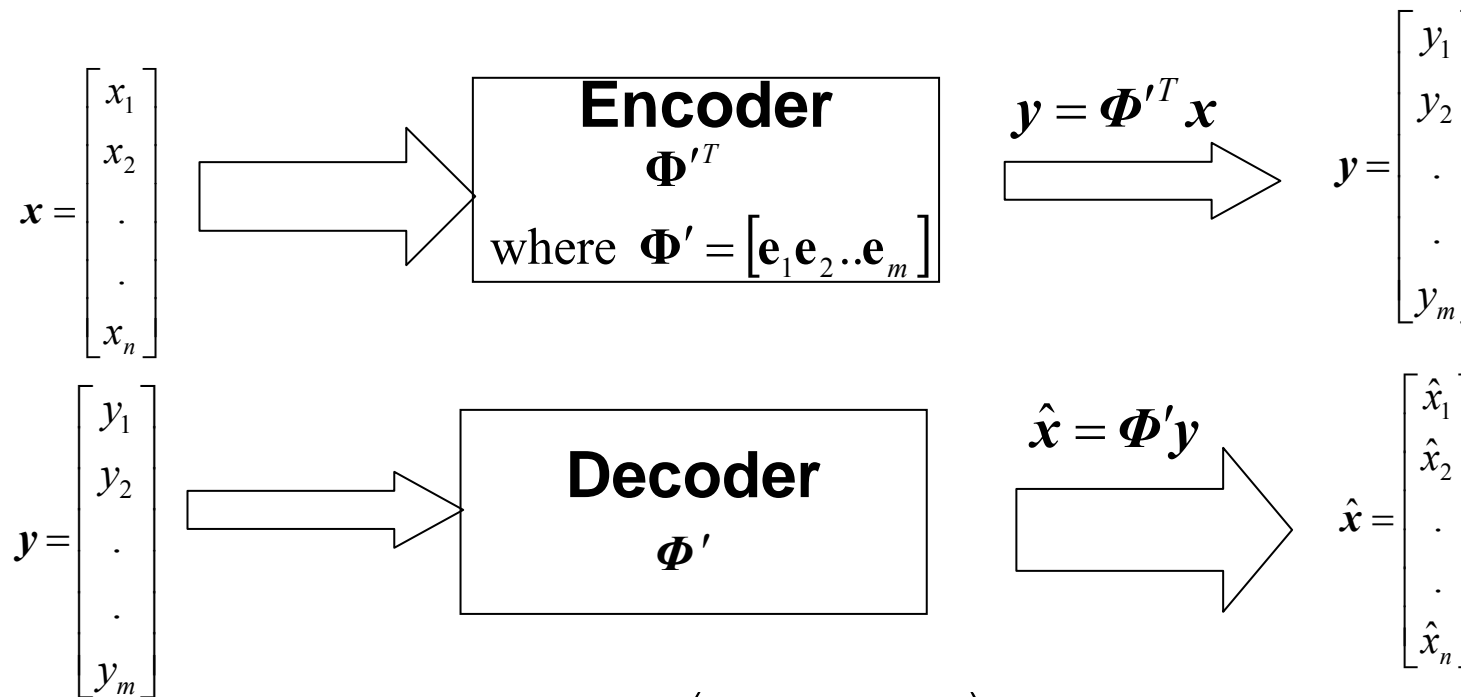

$$\text{minimize } E_x \left((\hat{\mathbf{x}} - \mathbf{x})^T (\hat{\mathbf{x}} - \mathbf{x}) \right)$$

Principle Component Analysis

- Data compression in communication

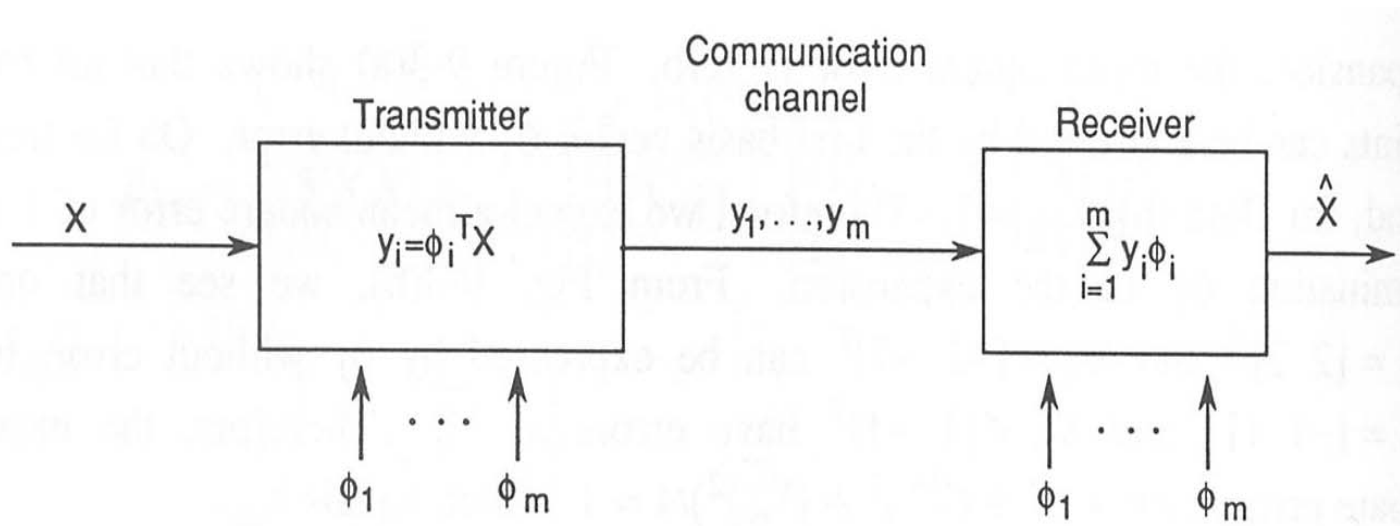

- PCA is an optimal transform for signal representation and dimensional reduction, but not necessary for classification tasks, such as speech recognition
- PCA needs no prior information (e.g. class distributions) of the sample patterns

Principle Component Analysis

- Example 1: principal components of some data points

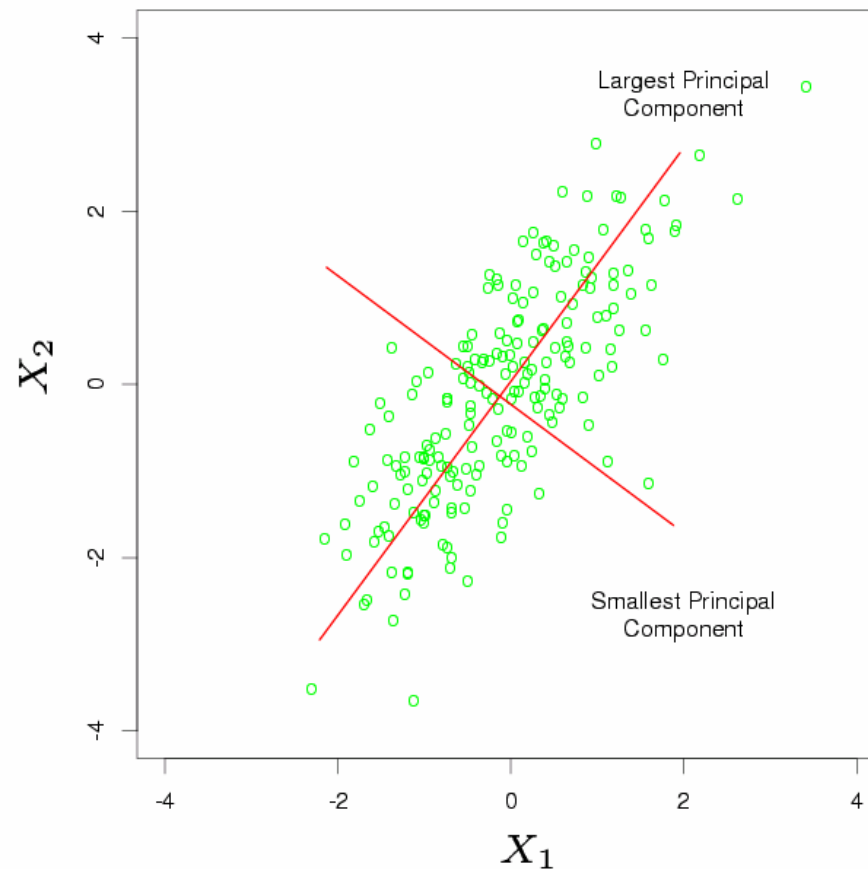

Principle Component Analysis

- Example 2: feature transformation and selection

Correlation matrix
for old feature
dimensions

TABLE 3.2 The correlation matrix for Iris data

	Feature 1	Feature 2	Feature 3	Feature 4
Feature 1	1.0000	-0.1094	0.8718	0.8180
Feature 2	-0.1094	1.0000	-0.4205	-0.3565
Feature 3	0.8718	-0.4205	1.0000	0.9628
Feature 4	0.8180	-0.3565	0.9628	1.0000

New feature dimensions

TABLE 3.3 The eigenvalues for
Iris data

Feature	Eigenvalue
Feature 1	2.91082
Feature 2	0.92122
Feature 3	0.14735
Feature 4	0.02061

$$R = (2.91082 + 0.92122) / (2.91082 + 0.92122 + 0.14735 + 0.02061) \\ = 0.958 > 0.95$$

threshold for information content reserved

Principle Component Analysis

- Example 3: Image Coding

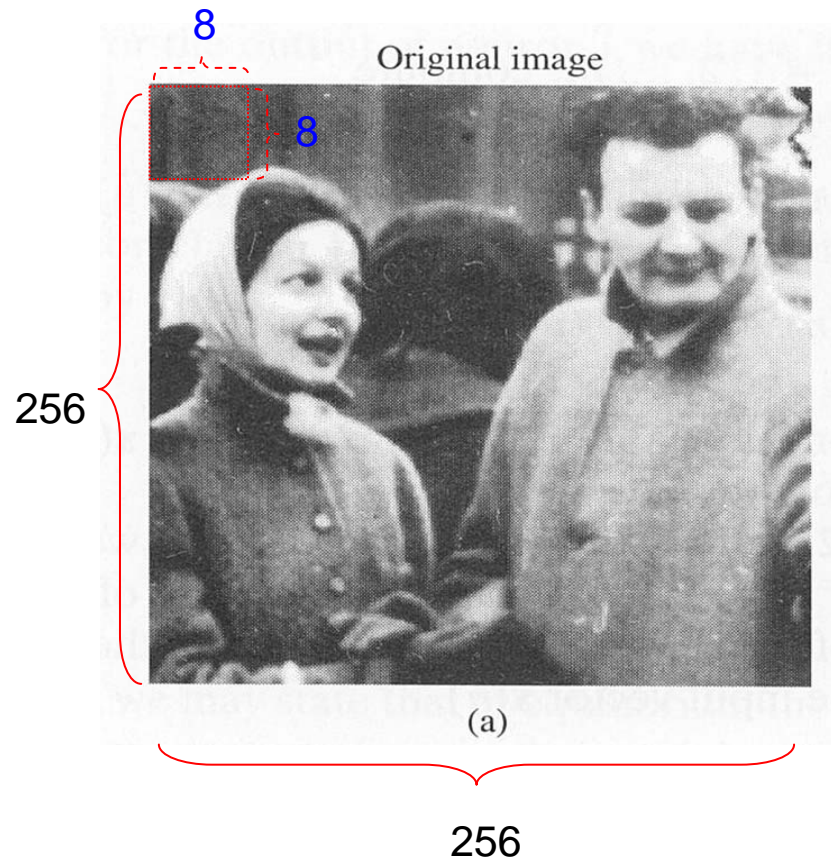

Principle Component Analysis

- Example 3: Image Coding (cont.)

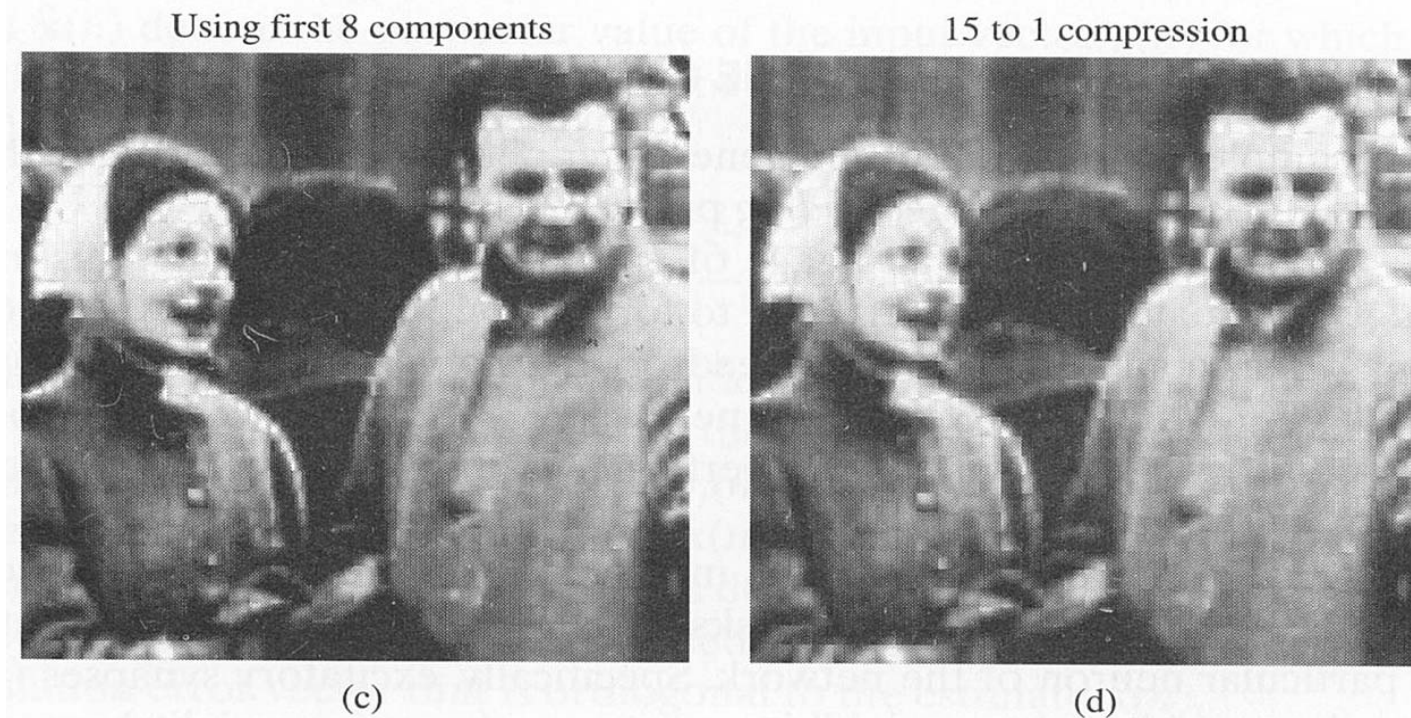

FIGURE 8.9 (a) An image of parents used in the image coding experiment. (b) 8×8 masks representing the synaptic weights learned by the GHA. (c) Reconstructed image of parents obtained using the dominant 8 principal components without quantization. (d) Reconstructed image of parents with 15 to 1 compression ratio using quantization.

Principle Component Analysis

Eigenface and Eigenvoice

- Example 4: Eigenface in face recognition (1990)
 - Consider an individual image to be a linear combination of a small number of face components or “eigenface” derived from a set of reference images

$$\mathbf{x}_1 = \begin{bmatrix} x_{1,1} \\ x_{1,2} \\ \cdot \\ \cdot \\ x_{1,n} \end{bmatrix}, \mathbf{x}_2 = \begin{bmatrix} x_{2,1} \\ x_{2,2} \\ \cdot \\ \cdot \\ x_{2,n} \end{bmatrix}, \dots, \mathbf{x}_L = \begin{bmatrix} x_{L,1} \\ x_{L,2} \\ \cdot \\ \cdot \\ x_{L,n} \end{bmatrix}$$

- Steps
 - Convert each of the L reference images into a vector of floating point numbers representing light intensity in each pixel
 - Calculate the covariance/correlation matrix between these reference vectors
 - Apply Principal Component Analysis (PCA) find the eigenvectors of the matrix: the eigenfaces
 - Besides, the vector obtained by averaging all images are called “eigenface 0”. The other eigenface from “eigenface 1” onwards model the variations from this average face

Principle Component Analysis

Eigenface and Eigenvoice

- Example 4: Eigenface in face recognition (cont.)
 - Steps
 - Then the faces are then represented as eigenvoice 0 plus a linear combination of the remain K ($K \leq L$) eigenfaces
 - The Eigenface approach persists the minimum mean-squared error criterion
 - Incidentally, the eigenfaces are not themselves usually plausible faces, only directions of variations between faces

$$\hat{\mathbf{x}}_i = \bar{\mathbf{x}} + w_{i,1} \mathbf{e}(1) + w_{i,2} \mathbf{e}(2) + \dots + w_{i,K} \mathbf{e}(K)$$
$$\Rightarrow \mathbf{y}_i = [1, w_{i,1}, w_{i,2}, \dots, w_{i,K}]$$

Feature vector of a person i

Principle Component Analysis

Eigenface and Eigenvoice

- Example 5: Eigenvoice in speaker adaptation (PSTL, 2000)
 - Steps
 - Concatenating the regarded parameters for each speaker r to form a huge vector $\mathbf{a}^{(r)}$ (a supervectors)
 - SD model mean parameters (μ)

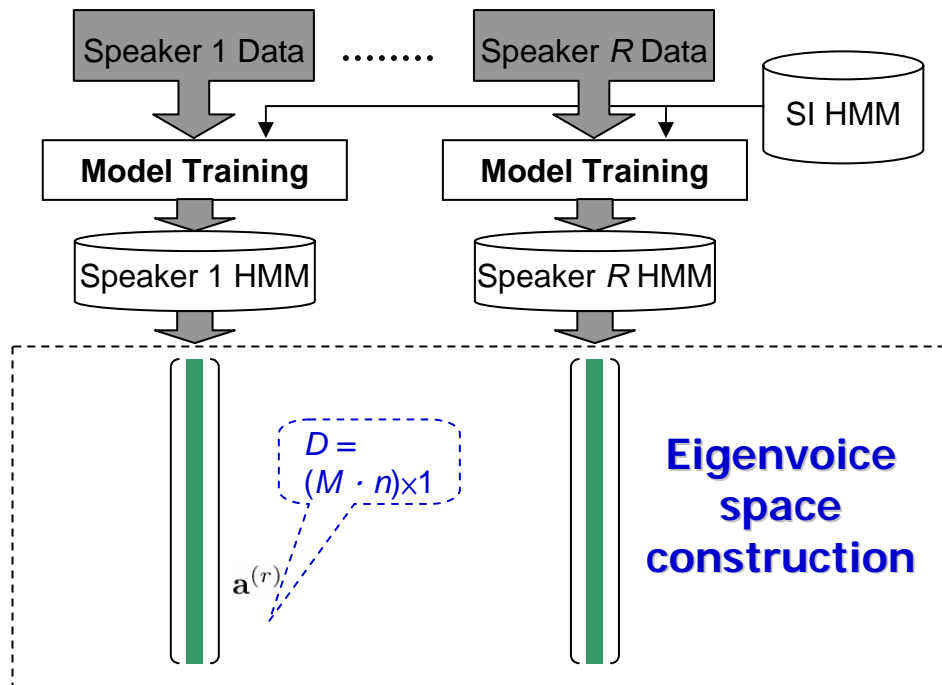

Each new speaker S is represented by a point P in K -space

$$\mathbf{P}_i = \mathbf{e}(0) + w_{i,1} \mathbf{e}(1) + w_{i,2} \mathbf{e}(2) + \dots + w_{i,K} \mathbf{e}(K)$$

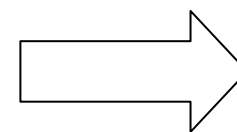

Principal Component Analysis

Principle Component Analysis

Eigenface and Eigenvoice

- Example 4: Eigenvoice in speaker adaptation (cont.)

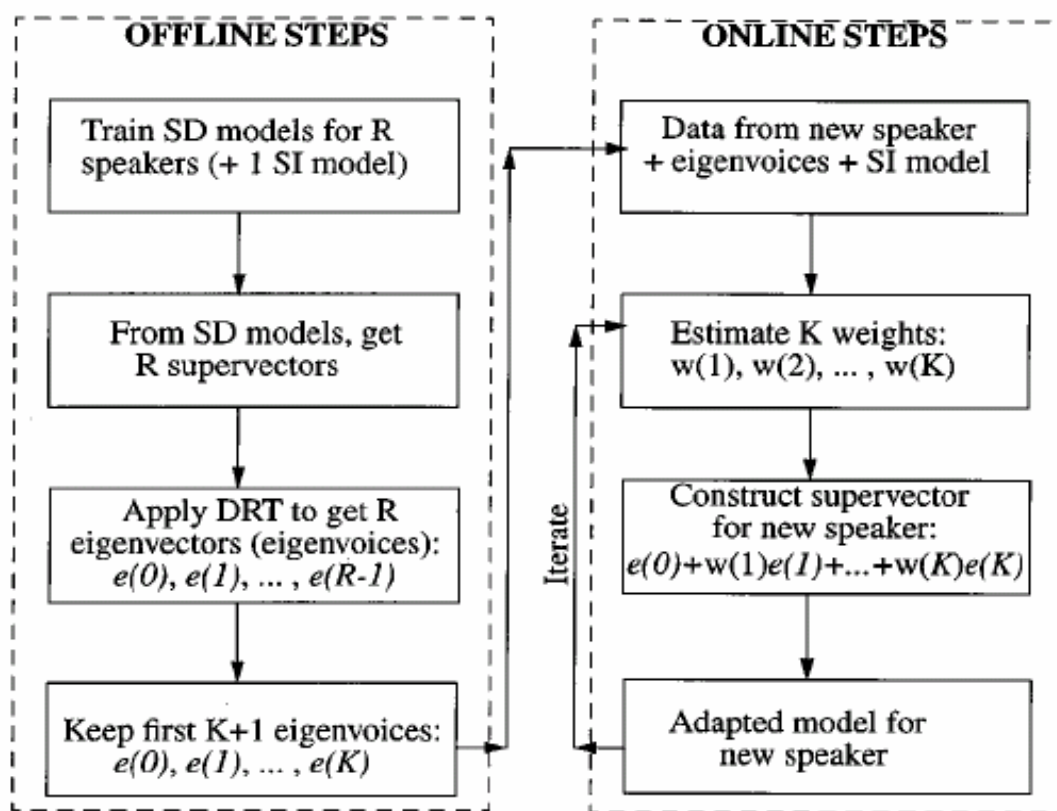

Fig. 1. Block diagram for eigenvoice speaker adaptation

Principle Component Analysis

Eigenface and Eigenvoice

- Example 5: Eigenvoice in speaker adaptation (cont.)
 - Dimension 1 (eigenvoice 1):
 - Correlate with pitch or sex
 - Dimension 2 (eigenvoice 2):
 - Correlate with amplitude
 - Dimension 3 (eigenvoice 3):
 - Correlate with second-formant movement

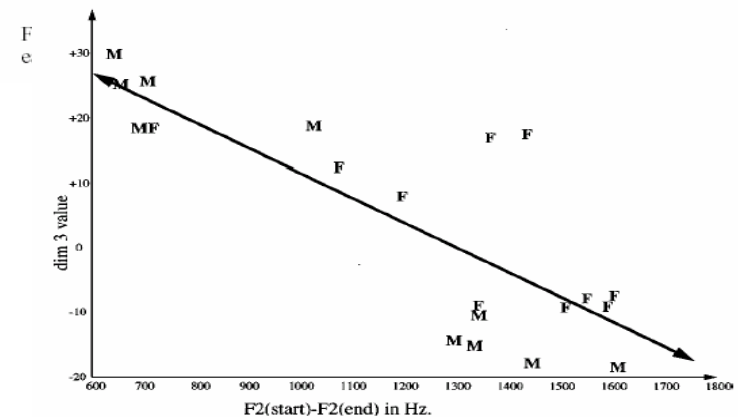
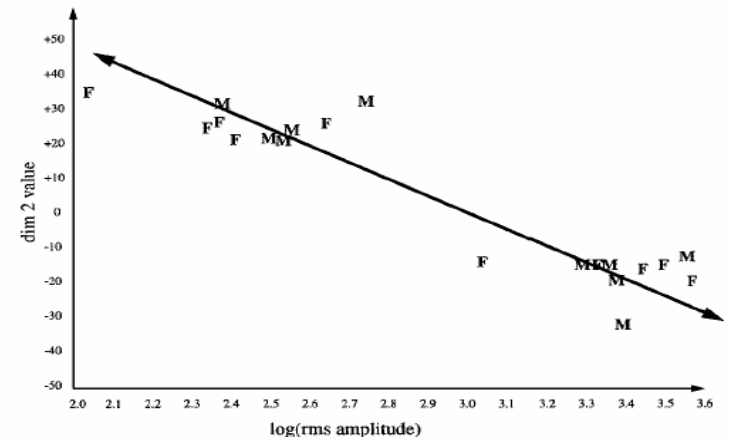

Fig. 4. Dimension 3 versus F2(start)-F2(end) for "U," extreme *M* and *F* in each speaker set

Linear Discriminant Analysis (LDA)

- Also called
 - Fisher's Linear Discriminant Analysis, Fisher-Rao Linear Discriminant Analysis
 - Fisher (1936): introduced it for two-class classification
 - Rao (1965): extended it to handle multiple-class classification

Linear Discriminant Analysis

- Given a set of sample vectors with labeled (class) information, try to find a linear transform \mathbf{W} such that the ratio of **average between-class variation** over **average within-class variation** is maximal

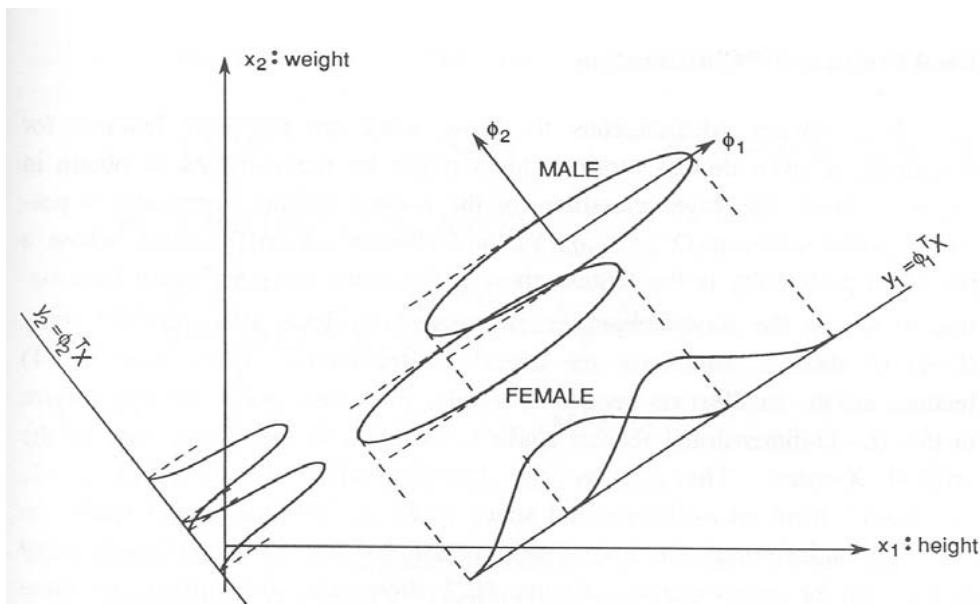

Fig. 10-1 An example of feature extraction for classification.

Within-class distributions are assumed here to be Gaussians With equal variance in the two-dimensional sample space

Linear Discriminant Analysis

- Suppose there are N sample vectors \mathbf{x}_i with dimensionality n , each of them belongs to one of the J classes $g(\mathbf{x}_i) = j$, $j \in \{1, 2, \dots, J\}$, $g(\cdot)$ is class index

- The sample mean is: $\bar{\mathbf{x}} = \frac{1}{N} \sum_{i=1}^N \mathbf{x}_i$

- The class sample means are: $\bar{\mathbf{x}}_j = \frac{1}{N_j} \sum_{g(\mathbf{x}_i)=j} \mathbf{x}_i$

- The class sample covariances are: $\Sigma_j = \frac{1}{N_j} \sum_{g(\mathbf{x}_i)=j} (\mathbf{x}_i - \bar{\mathbf{x}}_j)(\mathbf{x}_i - \bar{\mathbf{x}}_j)^T$

- The **average within-class variation** before transform

$$\mathbf{S}_w = \frac{1}{N} \sum_j N_j \Sigma_j$$

- The **average between-class variation** before transform

$$\mathbf{S}_b = \frac{1}{N} \sum_j N_j (\bar{\mathbf{x}}_j - \bar{\mathbf{x}})(\bar{\mathbf{x}}_j - \bar{\mathbf{x}})^T$$

Linear Discriminant Analysis

- If the transform $\mathbf{W} = [\mathbf{w}_1 \mathbf{w}_2 \dots \mathbf{w}_m]$ is applied
 - The sample vectors will be $\mathbf{y}_i = \mathbf{W}^T \mathbf{x}_i$
 - The sample mean will be $\bar{\mathbf{y}} = \frac{1}{N} \sum_{i=1}^N \mathbf{W}^T \mathbf{x}_i = \mathbf{W}^T \left(\frac{1}{N} \sum_{i=1}^N \mathbf{x}_i \right) = \mathbf{W}^T \bar{\mathbf{x}}$
 - The class sample means will be $\bar{\mathbf{y}}_j = \frac{1}{N_j} \sum_{g(\mathbf{x}_i)=j} \mathbf{W}^T \mathbf{x}_i = \mathbf{W}^T \bar{\mathbf{x}}_j$
 - The **average within-class variation** will be

$$\begin{aligned} \tilde{\mathbf{S}}_w &= \frac{1}{N} \sum_j N_j \left\{ \frac{1}{N_j} \cdot \sum_{g(\mathbf{x}_i)=j} \left(\mathbf{W}^T \mathbf{x}_i - \frac{1}{N_j} \sum_{g(\mathbf{x}_i)=j} (\mathbf{W}^T \mathbf{x}_i) \right) \left(\mathbf{W}^T \mathbf{x}_i - \frac{1}{N_j} \sum_{g(\mathbf{x}_i)=j} (\mathbf{W}^T \mathbf{x}_i) \right)^T \right\} \\ &= \mathbf{W}^T \left\{ \frac{1}{N} \sum_j N_j \boldsymbol{\Sigma}_j \right\} \mathbf{W} \\ &= \mathbf{W}^T \mathbf{S}_w \mathbf{W} \end{aligned}$$

Linear Discriminant Analysis

- If the transform $\mathbf{W} = [\mathbf{w}_1 \mathbf{w}_2 \dots \mathbf{w}_m]$ is applied
 - Similarly, the **average between-class variation** will be

$$\tilde{\mathbf{S}}_b = \mathbf{W}^T \mathbf{S}_b \mathbf{W}$$

- Try to find optimal \mathbf{W} such that the following criterion function is maximized

$$J(\mathbf{W}) = \frac{|\tilde{\mathbf{S}}_b|}{|\tilde{\mathbf{S}}_w|} = \frac{|\mathbf{W}^T \mathbf{S}_b \mathbf{W}|}{|\mathbf{W}^T \mathbf{S}_w \mathbf{W}|}$$

- A close form solution: the column vectors of an optimal matrix \mathbf{W} are the generalized eigenvectors corresponding to the largest eigenvalues in

$$\mathbf{S}_b \mathbf{w}_i = \lambda_i \mathbf{S}_w \mathbf{w}_i$$

- That is, \mathbf{w}_i 's are the eigenvectors corresponding to the largest eigenvalues of $\mathbf{S}_w^{-1} \mathbf{S}_b$

$$\mathbf{S}_w^{-1} \mathbf{S}_b \mathbf{w}_i = \lambda_i \mathbf{w}_i$$

Linear Discriminant Analysis

- Proof:

$$\because \hat{\mathbf{W}} = \arg \max_{\hat{\mathbf{W}}} J(\mathbf{W}) = \arg \max_{\hat{\mathbf{W}}} \frac{|\tilde{\mathbf{S}}_b|}{|\tilde{\mathbf{S}}_w|} = \arg \max_{\hat{\mathbf{W}}} \frac{|\mathbf{W}^T \mathbf{S}_b \mathbf{W}|}{|\mathbf{W}^T \mathbf{S}_w \mathbf{W}|}$$

Or, for each column vector \mathbf{w}_i of \mathbf{W} , we want to find that :

$$\text{The quadratic form has optimal solution : } \lambda_i = \frac{\mathbf{w}_i^T \mathbf{S}_b \mathbf{w}_i}{\mathbf{w}_i^T \mathbf{S}_w \mathbf{w}_i}$$

$$\Rightarrow \frac{\partial \lambda_i}{\partial \mathbf{w}_i} = \frac{2\mathbf{S}_b \mathbf{w}_i (\mathbf{w}_i^T \mathbf{S}_w \mathbf{w}_i) - 2\mathbf{S}_w \mathbf{w}_i (\mathbf{w}_i^T \mathbf{S}_b \mathbf{w}_i)}{(\mathbf{w}_i^T \mathbf{S}_w \mathbf{w}_i)^2} = 0$$

$$\Rightarrow \frac{\mathbf{S}_b \mathbf{w}_i (\mathbf{w}_i^T \mathbf{S}_w \mathbf{w}_i)}{(\mathbf{w}_i^T \mathbf{S}_w \mathbf{w}_i)^2} - \frac{\mathbf{S}_w \mathbf{w}_i (\mathbf{w}_i^T \mathbf{S}_b \mathbf{w}_i)}{(\mathbf{w}_i^T \mathbf{S}_w \mathbf{w}_i)^2} = 0$$

$$\frac{\mathbf{S}_b \mathbf{w}_i}{\mathbf{w}_i^T \mathbf{S}_w \mathbf{w}_i} - \frac{\mathbf{S}_w \mathbf{w}_i}{\mathbf{w}_i^T \mathbf{S}_w \mathbf{w}_i} \lambda_i = 0 \quad \left(\because \lambda_i = \frac{\mathbf{w}_i^T \mathbf{S}_b \mathbf{w}_i}{\mathbf{w}_i^T \mathbf{S}_w \mathbf{w}_i} \right)$$

$$\Rightarrow \mathbf{S}_b \mathbf{w}_i - \lambda_i \mathbf{S}_w \mathbf{w}_i = 0 \Rightarrow \mathbf{S}_b \mathbf{w}_i = \lambda_i \mathbf{S}_w \mathbf{w}_i$$

$$\Rightarrow \mathbf{S}_w^{-1} \mathbf{S}_b \mathbf{w}_i = \lambda_i \mathbf{w}_i$$

$$\left(\frac{\mathbf{F}}{\mathbf{G}} \right)' = \frac{\mathbf{F}'\mathbf{G} - \mathbf{G}'\mathbf{F}}{\mathbf{G}^2}$$

$$\frac{d(\mathbf{x}^T \mathbf{C} \mathbf{x})}{d\mathbf{x}} = (\mathbf{C} + \mathbf{C}^T) \mathbf{x}$$

Linear Discriminant Analysis

- Example 1: Experiments on Speech Signal Processing

Covariance Matrix of the 18-Mel-filter-bank vectors

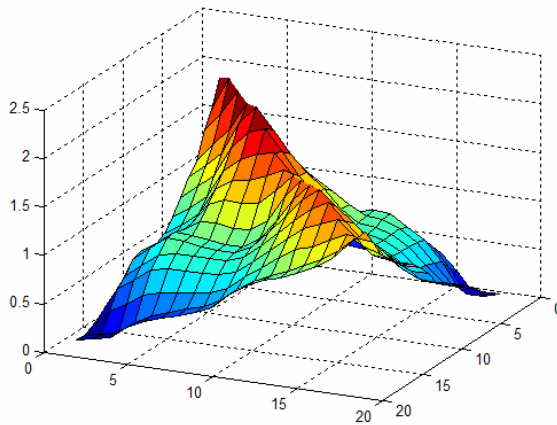

Calculated using Year-99's 5471 files

$$\Sigma = \frac{1}{N} \sum_{\mathbf{x}_i} (\mathbf{x}_i - \bar{\mathbf{x}})(\mathbf{x}_i - \bar{\mathbf{x}})^T$$

Covariance Matrix of the 18-cepstral vectors

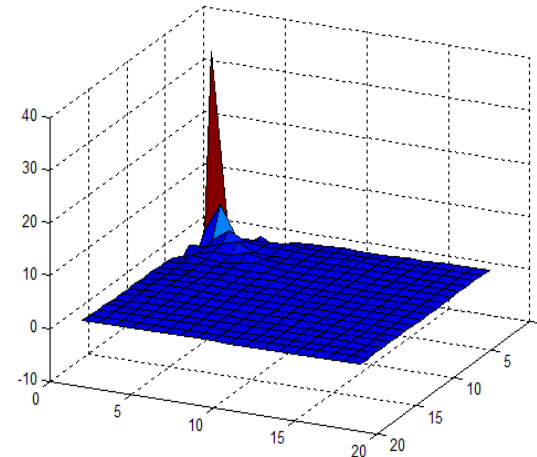

Calculated using Year-99's 5471 files

$$\Sigma' = \frac{1}{N} \sum_{\mathbf{y}_i} (\mathbf{y}_i - \bar{\mathbf{y}})(\mathbf{y}_i - \bar{\mathbf{y}})^T$$

After Cosine Transform

Experiments on Speech Signal Processing

- Example1: Experiments on Speech Signal Processing (cont.)

Covariance Matrix of the 18-PCA-cepstral vectors Covariance Matrix of the 18-LDA-cepstral vectors

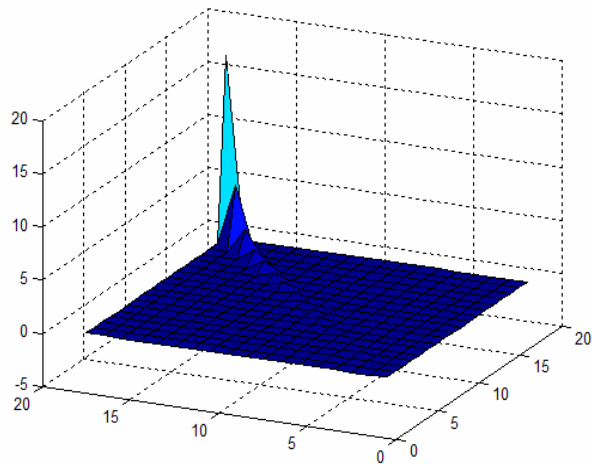

Calculated using Year-99's 5471 files

After PCA Transform

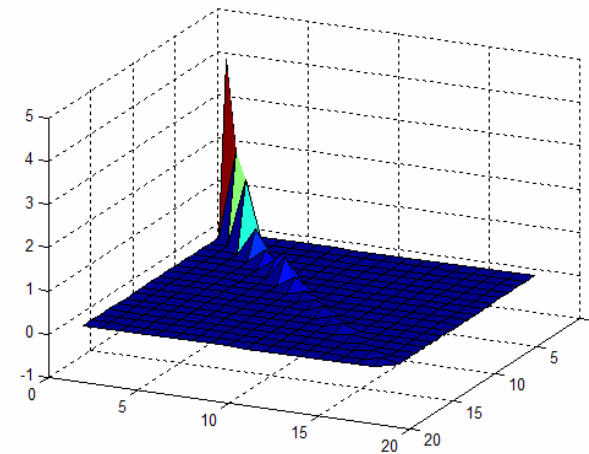

Calculated using Year-99's 5471 files

After LDA Transform

	Character Error Rate	
	TC	WG
MFCC	26.32	22.71
LDA-1	23.12	20.17
LDA-2	23.11	20.11

PCA vs. LDA

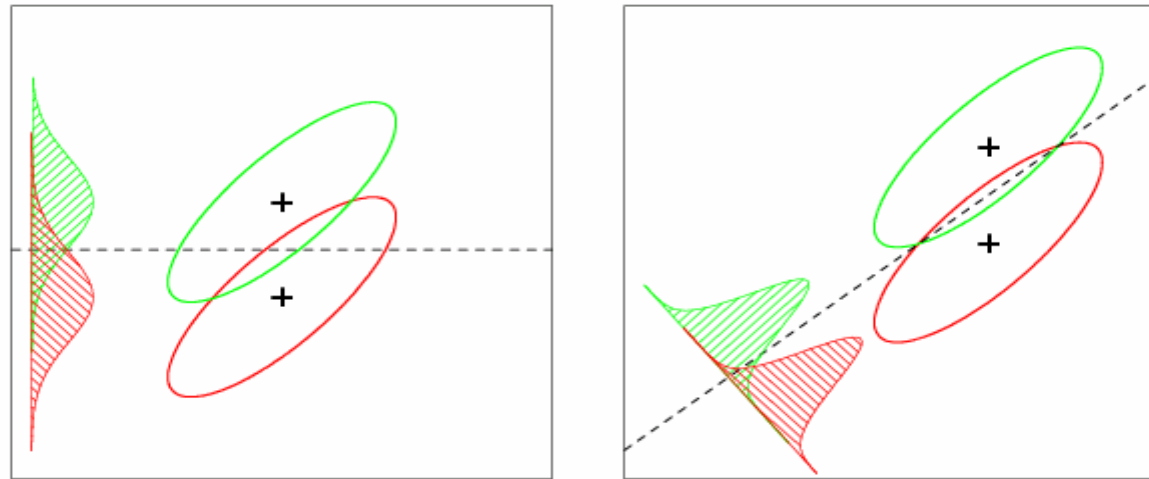

Figure 4.9: *Although the line joining the centroids defines the direction of greatest centroid spread, the projected data overlap because of the covariance (left panel). The discriminant direction minimizes this overlap for Gaussian data (right panel).*

LDA vs. HDA

- HDA: Heteroscedastic Discriminant Analysis

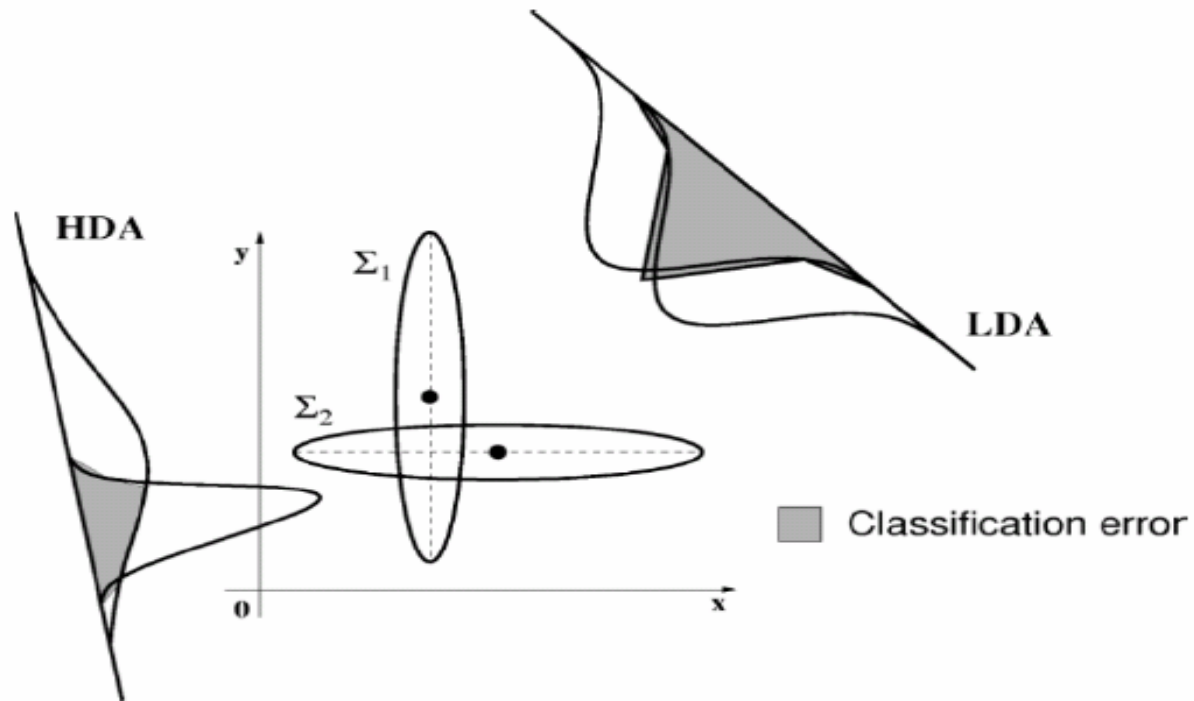

Fig. 1. Difference between LDA and HDA.

HW-2 Feature Transformation

- Given two data sets ([MaleData](#), [FemaleData](#)) in which each row is a sample with 18 features, please perform the following operations:
 1. Merge these two data sets and find/plot the covariance matrix for the merged data set.
 2. Apply PCA and LDA transformations to the merged data set, respectively. Also, find/plot the covariance matrices for transformations, respectively. Describe the phenomena that you have observed.
 3. Use the first two principal components of PCA as well as the first two eigenvectors of LDA to represent the merged data set. Selectively plot portions of samples from MaleData and FemaleData, respectively. Describe the phenomena that you have observed.

HW-2 Feature Transformation (cont.)

6.42713	6.63794	7.06637	7.88889	8.28665	9.13144	9.15820	9.02314	9.06447	9.54492	9.64417	9.39750	9.54539	9.66743	9.96106	10.31767	10.27543	10.35846
6.60918	6.68978	7.54557	7.51135	8.41962	9.19990	8.97876	8.84358	9.17819	9.38652	9.18760	9.15817	9.67501	9.86622	9.86302	10.19308	10.28680	10.20568
6.41962	7.13809	7.66789	7.36502	8.29559	9.72309	9.25206	8.89061	9.23610	9.54463	9.61080	9.90144	9.84137	9.87632	10.17686	10.10185	10.39783	10.18437
6.86355	7.00569	7.17471	8.15614	8.71617	9.41083	9.44752	9.21923	9.35536	9.64052	9.41545	9.77079	9.81874	9.72490	10.12627	10.20459	10.63373	10.43855
7.22548	6.75456	7.23428	7.96735	8.45112	9.24918	9.33575	9.05005	9.58763	9.98788	9.81818	9.76883	9.92221	9.84083	10.19516	10.26957	10.47222	10.41586
7.37737	6.37170	7.55167	7.51087	8.95966	9.18450	8.84421	8.89329	9.70726	10.11613	9.69935	9.83229	9.77153	9.98695	10.22368	10.27461	10.28110	10.23929
6.31627	7.09834	7.44018	7.94135	8.97552	9.09170	9.58235	9.07187	9.48562	9.95253	9.47215	9.50158	9.88541	10.03101	10.17139	10.19946	10.51533	10.47495
7.32665	7.13843	7.90410	7.89386	8.75346	9.18233	10.11025	9.50357	9.42500	9.86274	9.40006	9.87786	9.84763	10.17598	10.02787	10.44857	10.36439	10.15492
6.87833	6.38132	7.82116	7.91663	8.70769	9.36655	9.66250	9.53536	9.85095	9.74988	10.11805	9.96693	9.84836	9.97311	10.06228	10.27342	10.59408	10.49595
6.85021	6.65767	7.23630	8.04771	8.48361	9.55667	9.95110	9.61122	9.05134	9.69155	9.96958	9.62920	9.90382	9.78647	10.36104	10.26381	10.40579	10.29332
7.22140	7.02353	7.77372	8.44543	9.04546	9.48666	9.63974	9.36783	9.19456	10.16187	9.64667	10.10419	9.88623	9.73151	9.99944	10.25832	10.48060	10.30917
7.04571	7.34592	8.25410	8.51151	8.84546	8.73990	9.55656	9.70503	9.36017	9.99317	9.50287	9.90498	10.22401	10.21169	9.99052	10.15059	10.43741	10.29127
6.40109	6.62064	7.85343	8.41806	8.80033	8.95982	9.85976	9.72723	9.83326	9.75391	9.46737	9.78288	10.33103	10.25947	10.10942	10.33977	10.69843	10.61361
7.03983	6.81402	8.06266	8.49128	9.09858	9.49709	9.50981	9.40213	9.62871	9.36644	9.69002	9.93724	10.11084	10.38737	10.29060	10.29727	10.65062	10.87061
7.48447	7.44521	8.31400	9.00737	8.76473	9.58358	9.73854	9.70255	10.06008	10.47637	9.98790	9.78771	10.16327	10.27081	10.72976	10.63497	10.65275	11.12336
8.95152	10.14082	11.47406	11.95361	11.70543	12.49259	11.92901	10.78543	10.28769	10.54797	10.36536	10.82128	12.31664	12.38622	11.08099	10.52101	10.49685	10.82546
9.28539	10.41168	12.07715	12.69397	12.28251	13.02032	12.16224	10.87808	10.60156	10.51851	10.51198	11.84690	13.09367	13.19682	11.56034	10.36879	10.73642	11.23687
9.25284	10.39935	12.28775	13.09387	12.39200	13.04389	12.22348	11.28230	10.57541	10.58302	10.49196	11.57102	12.65899	12.78191	11.54582	10.47776	11.71009	12.07101
9.48814	10.57697	12.14462	13.05838	12.27252	12.92096	12.01746	11.10978	10.71202	10.45176	10.20901	11.49229	12.56191	12.74920	11.53024	10.50136	11.48792	12.38682
9.24510	10.53409	12.10514	12.99560	12.26131	12.82944	11.99671	11.09576	10.60223	10.62066	10.69532	11.52727	12.55299	12.58644	11.41030	10.98138	11.54383	12.39193
9.37856	10.56379	12.15502	13.03582	12.39346	12.79591	11.99477	11.25890	10.59781	10.41142	10.29753	11.61179	12.76901	12.82854	11.53489	10.26693	11.59377	12.46711
9.10574	10.36238	12.10913	13.03047	12.30543	12.79777	11.82454	11.11023	9.95303	10.23726	10.21457	11.65016	12.75013	12.79919	11.44790	10.15221	11.34570	12.17819
9.25286	10.39592	12.10761	13.02590	12.34146	12.79751	11.87436	11.27570	10.28222	10.08590	10.16289	11.58145	12.79790	12.92117	11.85415	11.04553	11.50033	12.03395
9.37944	10.22634	11.99594	12.97796	12.20640	12.68950	11.63688	10.97845	10.14909	10.25551	10.07726	11.59147	12.75670	12.87878	11.58397	10.53411	11.23498	11.82416
9.24735	10.33095	11.90092	12.90967	12.19729	12.57357	11.55529	10.94830	10.37612	9.99572	10.02343	11.44121	12.66732	12.85391	11.41223	10.18042	11.05130	11.66860
9.35116	10.40006	11.91490	12.92593	12.26836	12.59967	11.73072	11.07363	10.42829	10.38190	10.02016	11.40167	12.67601	12.85032	11.48816	10.23896	11.00952	11.80363
8.85565	10.22952	11.97470	12.93747	12.32025	12.69687	11.91195	11.12610	10.04652	9.74522	9.84040	11.60561	12.81711	12.93019	11.65117	9.94210	11.10972	11.99067
9.06311	10.24851	11.99336	12.94507	12.31958	12.76722	11.92754	11.29551	10.84976	10.67713	10.83308	11.72299	12.74011	12.89174	11.78875	10.96543	11.26600	11.78640
9.09109	10.14237	11.89207	12.92688	12.24762	12.85326	11.95840	11.03245	10.29068	10.24957	10.27929	11.71948	12.71321	12.68492	11.41932	10.22840	10.86876	11.48627
8.86112	10.11202	11.76434	12.84603	12.17904	13.02281	12.22743	11.03697	10.28548	10.17738	10.02944	11.64224	12.81149	12.83681	11.66230	10.22197	11.06236	11.69995
8.95651	10.17607	11.70941	12.79840	12.22853	13.30465	12.69674	11.08070	10.19255	10.17787	10.25474	11.54506	12.74126	12.82745	11.66595	10.67840	11.28033	11.46947
8.95184	10.11466	11.58894	12.70559	12.22427	13.43013	12.99500	11.03695	10.67592	10.59266	10.27218	11.53677	12.75268	12.84525	11.55395	10.62605	11.29321	11.76728
8.93481	9.98079	11.53426	12.61443	12.18141	13.39686	13.12180	11.24372	11.18761	11.21561	10.94448	11.49001	12.90905	12.92089	11.51464	11.14149	11.56695	11.34264
8.72390	9.95325	11.41650	12.50804	11.93665	13.10813	13.55141	11.87676	10.84982	10.72457	10.66934	11.68744	12.83971	12.57063	10.68780	10.36828	11.23385	11.65968
8.86731	9.81090	11.35759	12.46365	11.73738	12.92556	13.85868	12.05668	11.03708	10.91234	11.01318	11.93650	12.50144	12.07413	10.67163	10.11630	11.95211	11.41643
8.80004	9.90337	11.28811	12.37457	11.65101	12.55219	13.91458	12.54423	11.45110	11.56509	11.62036	11.89225	11.84936	11.56170	10.11295	10.03426	10.44886	11.15139
8.57503	9.97730	11.39499	12.22883	11.38133	12.14903	13.53391	12.64970	11.92921	12.17885	11.20951	11.04259	10.90964	11.08990	10.09882	9.93701	10.45472	10.65229
8.75854	9.98532	11.42928	12.01617	10.91319	11.97503	13.51339	12.86567	12.40181	12.14269	10.32589	10.47594	10.34628	10.29207	9.72180	9.70791	10.20271	10.23657
8.51064	9.97845	11.34774	11.85436	10.77862	11.96920	13.59716	13.01747	12.50466	11.12553	10.26017	10.24660	9.95529	10.16539	9.91504	9.86165	10.05572	10.10832
8.75284	9.97322	11.25107	11.53580	10.56970	11.97240	13.64676	13.00659	12.59076	11.15314	10.01281	10.27642	10.30719	9.83591	9.89535	9.69011	10.18799	10.07413
8.69811	9.91990	11.20998	11.35521	10.37719	11.88766	13.57117	12.64817	12.11702	11.51724	10.04957	10.00606	9.78021	10.03180	10.04367	9.96540	10.08658	9.99362
8.68049	9.92636	11.23110	11.61208	10.79860	12.07838	13.56636	12.68811	12.66671	12.70132	10.51101	10.28009	9.94354	10.01544	10.24593	10.05090	10.04164	10.39702
8.59695	9.95619	11.23503	12.34665	11.84855	12.56838	13.74129	12.87108	12.25929	12.86958	11.52864	11.20175	11.33119	11.15635	10.20941	10.03565	10.47241	11.27322
9.21813	10.07835	11.23133	12.52400	12.18068	12.65421	14.01153	13.15049	11.75339	11.69041	11.44919	11.91691	12.59050	12.06584	10.28150	10.16722	10.63046	11.66016
9.45242	9.83172	10.99231	12.37461	12.37894	12.67601	14.08033	13.31300	11.63499	11.57846	11.20036	11.72327	12.59090	12.73404	11.21351	10.89487	11.06791	11.73133
9.16915	9.38694	10.78770	12.23222	12.46109	12.79289	14.14283	13.42151	11.68986	11.50380	11.17019	11.80490	12.45519	13.22823	11.71481	10.32775	10.48164	11.30554

HW-2 Feature Transformation (cont.)

- Plot Covariance Matrix

```
CoVar=[
    3.0    0.5    0.4;
    0.9    6.3    0.2;
    0.4    0.4    4.2;
];
colormap('default');
surf(CoVar);
```

- Eigen Decomposition

```
BE=[
    3.0    3.5    1.4;
    1.9    6.3    2.2;
    2.4    0.4    4.2;
];
WI=[
    4.0    4.1    2.1;
    2.9    8.7    3.5;
    4.4    3.2    4.3;
];
```

```
%LDA
IWI=inv(WI);
A=IWI*BE;
%PCA
A=BE+WI; % why ??

[V,D]=eig(A);
[V,D]=eigs(A,3);

fid=fopen('Basis','w');
for i=1:3 % feature vector length
    for j=1:3 % basis number
        fprintf(fid,'%10.10f ',V(i,j));
    end
    fprintf(fid,'\n');
end
fclose(fid);
```